

# JVC

## DOME TYPE CAMERA

# TK-C625

## INSTRUCTIONS

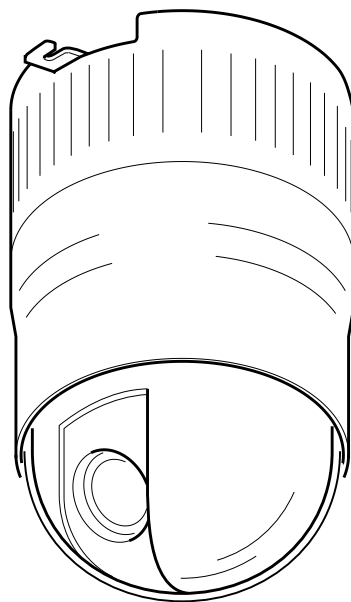



**For Customer Use:**

Enter below the Model No. and Serial No. which is located on the body. Retain this information for future reference.

Model No. **TK-C625**

Serial No. \_\_\_\_\_

**FOR USA AND CANADA**

	<b>CAUTION</b> RISK OF ELECTRIC SHOCK DO NOT OPEN	
<p>CAUTION: TO REDUCE THE RISK OF ELECTRIC SHOCK. DO NOT REMOVE COVER (OR BACK). NO USER-SERVICEABLE PARTS INSIDE. REFER SERVICING TO QUALIFIED SERVICE PERSONNEL.</p>		

 The lightning flash with arrowhead symbol, within an equilateral triangle is intended to alert the user to the presence of uninsulated "dangerous voltage" within the product's enclosure that may be of sufficient magnitude to constitute a risk of electric shock to persons.

 The exclamation point within an equilateral triangle is intended to alert the user to the presence of important operating and maintenance (servicing) instructions in the literature accompanying the appliance.

Due to design modifications, data given in this instruction book are subject to possible change without prior notice.

**WARNING:**  
**TO REDUCE THE RISK OF FIRE OR ELECTRIC SHOCK, DO NOT EXPOSE THIS APPLIANCE TO RAIN OR MOISTURE.**

**AVERTISSEMENT:**  
**POUR EVITER LES RISQUES D'INCENDIE OU D'ELECTROCUTION, NE PAS EXPOSER L'APPAREIL A L'HUMIDITE OU A LA PLUIE.**

**INFORMATION (FOR CANADA)**  
**RENSEIGNEMENT (POUR CANADA)**

This Class B digital apparatus complies with Canadian ICES-003.

Cet appareil numerique de la Class B est conforme a la norme NMB-003 du Canada.

**INFORMATION FOR USA**

**■ INFORMATION**  
This equipment has been tested and found to comply with the limits for a Class B digital device, pursuant to Part 15 of the FCC Rules.

These limits are designed to provide reasonable protection against harmful interference in a residential installation. This equipment generates, uses, and can radiate radio frequency energy and, if not installed and used in accordance with the instructions, may cause harmful interference to radio communications. However, there is no guarantee that interference will not occur in a particular installation.

If this equipment does cause harmful interference to radio or television reception, which can be determined by turning the equipment off and on, the user is encouraged to try to correct the interference by one or more of the following measures:

- Reorient or relocate the receiving antenna.
- Increase the separation between the equipment and receiver.
- Connect the equipment into an outlet on a circuit different from that to which the receiver is connected.
- Consult the dealer or an experienced radio/TV technician for help.

**■ CAUTION**  
CHANGES OR MODIFICATIONS NOT APPROVED BY JVC COULD VOID USER'S AUTHORITY TO OPERATE THE EQUIPMENT.

THIS DEVICE COMPLIES WITH PART 15 OF THE FCC RULES. OPERATION IS SUBJECT TO THE FOLLOWING TWO CONDITIONS: (1) THIS DEVICE MAY NOT CAUSE HARMFUL INTERFERENCE, AND (2) THIS DEVICE MUST ACCEPT ANY INTERFERENCE RECEIVED, INCLUDING INTERFERENCE THAT MAY CAUSE UNDESIRE OPERATION.

- This installation should be made by a qualified service person and should conform to all local codes.
- This installation shall be in accordance with the National Electrical Code, ANSI/NFPA 70.
- This product shall be powered by a Listed Class 2 power supply only.
- Any Mention in this manual of Alarm inputs/outputs have not been evaluated by UL to be used for Burglar Alarm Functionality.

These are general IMPORTANT SAFEGUARDS and certain items may not apply to all appliances.

# IMPORTANT SAFEGUARDS

1. Read all of these instructions.
2. Save these instructions for later use.
3. All warnings on the product and in the operating instructions should be adhered to.
4. Unplug this appliance system from the wall outlet before cleaning. Do not use liquid cleaners or aerosol cleaners. Use a damp cloth for cleaning.
5. Do not use attachments not recommended by the appliance manufacturer as they may cause hazards.
6. Do not use this appliance near water - for example, near a bathtub, washbowl, kitchen sink, or laundry tub, in a wet basement, or near a swimming pool, etc.
7. Do not place this appliance on an unstable cart, stand, or table. The appliance may fall, causing serious injury to a child or adult, and serious damage to the appliance.  
 Use only with a cart or stand recommended by the manufacturer, or sold with the appliance. Wall or shelf mounting should follow the manufacturer's instructions, and should use a mounting kit approved by the manufacturer.  
 An appliance and cart combination should be moved with care. Quick stops, excessive force, and uneven surfaces may cause the appliance and cart combination to overturn.
8. Slots and openings in the cabinet and the back or bottom are provided for ventilation, to insure reliable operation of the appliance and to protect it from overheating, these openings must not be blocked or covered. The openings should never be blocked by placing the appliance on a bed, sofa, rug, or other similar surface. This appliance should never be placed near or over a radiator or heat register. This appliance should not be placed in a built-in installation such as a bookcase unless proper ventilation is provided.
9. This appliance should be operated only from the type of power source indicated on the marking label. If you are not sure of the type of power supplied to your home, consult your dealer or local power company. For appliance designed to operate from battery power, refer to the operating instructions.
10. For added protection for this product during a lightning storm, or when it is left unattended and unused for long periods of time, unplug it from the wall outlet and disconnect the antenna or cable system. This will prevent damage to the product due to lightning and power-line surges.
11. Do not allow anything to rest on the power cord. Do not locate this appliance where the cord will be abused by persons walking on it.
12. Follow all warnings and instructions marked on the appliance.
13. Do not overload wall outlets and extension cords as this can result in fire or electric shock.
14. Never push objects of any kind into this appliance through cabinet slots as they may touch dangerous voltage points or short out parts that could result in a fire or electric shock. Never spill liquid of any kind on the appliance.
15. Do not attempt to service this appliance yourself as opening or removing covers may expose you to dangerous voltage or other hazards. Refer all servicing to qualified service personnel.
16. Unplug this appliance from the wall outlet and refer servicing to qualified service personnel under the following conditions:
  - a. When the power cord or plug is damaged or frayed.
  - b. If liquid has been spilled into the appliance.
  - c. If the appliance has been exposed to rain or water.
  - d. If the appliance does not operate normally by following the operating instructions. Adjust only those controls that are covered by the operating instructions as improper adjustment of other controls may result in damage and will often require extensive work by a qualified technician to restore the appliance to normal operation.
  - e. If the appliance has been dropped or the cabinet has been damaged.
  - f. When the appliance exhibits a distinct change in performance - this indicates a need for service.
17. When replacement parts are required, be sure the service technician has used replacement parts specified by the manufacturer that have the same characteristics as the original part. Unauthorized substitutions may result in fire, electric shock, or other hazards.
18. Upon completion of any service or repairs to this appliance, ask the service technician to perform routine safety checks to determine that the appliance is in safe operating condition.

PORTABLE CART WARNING  
(symbol provided by RETAC)



S3125A

Thank you for purchasing this product.  
 (These instructions are for TK-C625U/TK-C625E)  
 TK-C625U : For North American Market.  
 TK-C625E : For European Market.

“TK-C625” is used for common descriptions between both models in this manual.

Before beginning to operate this unit, please read the instruction manual carefully in order to make sure that the best possible performance is obtained.

## Characteristics

- **Day/Night Surveillance**  
 When the light is low, the camera is able to switch automatically to the high-sensitive (B&W) mode by turning the IR cut filter to ON/OFF.
- **Private Mask feature**  
 This feature enables setting to mask a certain portion of the shooting area if it is to be hidden.
- **Optical Zoom**  
 Closer surveillance is made possible using the x12 optical zoom lens.
- **Use of a bright zoom lens**  
 Maximum aperture ratio of F 1.6 (at the Wide end) and use of a bright zoom lens produces a highly sensitive color mode of 3.6 lx (AGC 20 dB, 50%).
- **High-speed Rotating Table**  
 High-speed rotating table with a horizontal panning speed of 180°/sec and vertical tilting speed of 120°/sec makes it possible to recall a preset position quickly.
- **High image quality**  
 Uses a camera with a high resolution of 0.38 mega pixels and a highly sensitive CCD to realize a high image quality of 540 lines (Typ.) and S/N50dB.

**How to Use This Manual**

**MEMO** : Points to pay attention to during operation.

**CAUTION** : Details for reference, such as functions or constraints during use.

 : Pages or items to refer to.

## Contents

<b>Safety Precautions</b>	<b>2</b>
<hr/>	
<b>IMPORTANT SAFEGUARDS</b>	<b>3</b>
<hr/>	
<b>Introduction</b>	<b>4</b>
Characteristics .....	4
Contents .....	4
Operating Precautions .....	5
Name and Function of Parts .....	7
<hr/>	
<b>Connections &amp; Installation</b>	<b>9</b>
Multi-Drop Communication System.....	9
Point-to-Point Communication System .....	11
Switch Settings.....	13
Cable Connections.....	16
Installing the Ceiling Mount.....	19
Installing the Camera .....	20
<hr/>	
<b>Setting Up the Camera Using RM-P2580</b>	<b>21</b>
Setup Procedure .....	21
Menu Screen Configuration .....	22
CAMERA FUNCTION 1 Screen.....	24
CAMERA FUNCTION 2 Screen.....	24
CAMERA TITLE/ALARM Screen .....	26
CAMERA ALC/VIDEO Screen .....	27
AUTO PAN/PATROL/TRACE Screen.....	28
POS. FUNCTION SET Screen.....	29
FACTORY SETTINGS Screen.....	30
PRIVATE MASK Setup .....	31
MANUAL PAN LIMIT Setup .....	32
CAMERA TITLE Setup.....	34
AREA DISPLAY Setup (TITLE).....	35
AREA DISPLAY Setup (DIRECTION).....	36
ALARM TITLE Setup.....	37
AUTO PAN Setup .....	38
AUTO PATROL Setup .....	39
AUTO TRACE Setup.....	40
POSITION TITLE Setup.....	41
<hr/>	
<b>Other</b>	<b>42</b>
Troubleshooting .....	42
Specifications .....	43

## Operating Precautions

### ■ WARNING

- Install the unit on a strong and stable surface.

This unit has been designed to revolve at high speed. Due to its weight (about 1.3 kg) and the vibrations it may be subjected to, the camera must be mounted to a sturdy and stable material. If the ceiling material lacks strength, for example if it is made of a decorative laminated material or plasterboard, then the mount should be reinforced using materials such as veneered plywood. If such reinforcement is inadequate, images may fluctuate due to vibration or, in the worst case, the camera may fall and cause a serious accident should there be anyone below it.

- For installation, use the provided ceiling mount and the optional flush mounted ceiling bracket, which is sold separately. When installing this device, the provided ceiling mount and the optional flush mounted ceiling bracket, which are sold separately should be used. Also be sure to connect the drop prevention wire and tighten all screws and nuts firmly.

- Power the unit with the rated power voltage. The power rating for this unit is 24 V AC, 50 Hz/60 Hz. If a power above this rating is supplied, a malfunction will occur or, in the worst case, smoke or fire may be produced.

- This unit offers a certain degree of protection against any damage either to itself or to its connection cable that might result from indirect lightning strikes, but it is not capable of preventing all damage by lightning strikes. For example it is not protected against a direct lightning strike. If lightning damage can be expected in the place where the unit is installed, be sure to take countermeasures by adding an arrester to the connection cable, etc.

- To save energy, turn the system off whenever it is not in use.
- This camera has been designed for indoor use. It cannot be used outdoors.
- This camera has been designed to be hung from a ceiling. Do not install it in an upright position on a surface or at an angle, as this may cause a malfunction or a noticeable shortening of its service life.
- Do not install or use the camera in the following locations.
  - In a place exposed to rain or water.
  - In a place containing vapor or oil soot, for example in a kitchen.
  - In a place outside the operating temperature range (-10°C to 50°C).
  - Near a source of strong radio waves or magnetism, radiation or X-rays.
  - In a place where corrosive gasses are generated.
  - In a place subject to vibrations.
  - In a place with excessive dust.
- Insufficient ventilation of the camera may cause a malfunction. Be careful not to block ventilation of the camera. This unit radiates heat from the panel surfaces (top panel and side panels). Do not install it in a place where a heat pool may form, such as near a wall.
- Do not install the camera in a place exposed to cold air, for example near to the air outlet of an air conditioner. Otherwise, moisture may become condensed inside the dome cover.
- Do not point the lens at a strong light source, for example under the sun. Doing so may cause the camera to malfunction.
- The camera incorporates an AGC circuit. As a result, when it is used under low light conditions the camera gain may increase automatically. This makes the picture appear uneven, however this is not a malfunction.
- When equipment that generates strong magnetism such as a transceiver is used near to the unit while the AGC circuit is ON, beat noise, etc may interfere with the picture. If a transceiver or similar equipment is used, keep it a distance of at least 3 meters from this unit.
- In auto iris mode, when the AGC circuit is ON, varying the iris with the iris control button may not change the picture brightness. This is due to the automatic gain boost by the AGC circuit. In this case, set AGC to OFF or use the manual iris mode.
- In auto iris mode, the iris control button may not function under certain brightness conditions (i.e. when a sufficient amount of light cannot be obtained). In this case, set the iris mode to manual.
- When the camera is used in ATW (Auto White balance) mode, the colors captured by the camera may differ from the actual colors being shot due to the mechanics of the auto-tracking operation within the white balance circuit. However, this is not a malfunction.

## Operating Precautions (continued)

- If a very bright object (such as a lamp) is being monitored, the picture may contain vertical lines (smear) above and below the bright object in the picture. This is a phenomenon normal to a solid-state image pickup device (CCD) and is not a malfunction.
- The electronic shutter speed of the camera has been set to 1/50 \*(1/60) second at the factory. If the camera is used under a fluorescent light source in an area with a local power frequency of 60 Hz \*(50 Hz), change the shutter speed to 1/120 \*(1/100) second using the remote control unit. (Note that the sensitivity will deteriorate slightly.) \*( ) : TK-C625U
- When the camera is used to monitor the same position over many hours (e.g. continuously for 24 hours a day) the contact resistance of the panning mechanism may increase. This may cause the picture to be affected by noise interference or the remote control operation becoming unstable. To prevent this from happening, once a week, turn the system off and on to initialize the camera and clean the contacts.
- Do not touch the lens on the dome cover directly by hand. Contamination of the cover will lead to deterioration of the picture quality.
- Since the dome cover is of a hemispherical shape, the picture tends to become distorted at the edges of the hemisphere. The edges of the hemisphere is masked for this camera. When the camera is tilted and pointed in the horizontal direction, therefore, edges of the hemisphere may enter the angle of view, hence causing the upper end of the screen to appear dark and the image to go out of focus. In this case, use the TILT LIMIT settings (Page 25) to prevent capturing the above areas.
- When an object is located near a light source or contains a large difference in brightness, a ghost may interfere with the picture. This phenomenon is due to the characteristics of the dome cover and the built-in lens and is not a malfunction.
- In particular, manual or auto pan operations near the TELE end may cause the screen to appear shaky (rotation is not smooth). This phenomenon is due to the characteristics of the motor and is not a malfunction.
- Observe the following points when carrying out maintenance of the camera.
  - Turn the system off before proceeding.
  - Clean the dome cover using a lens cleaning cloth (or tissue).  
The dome cover may become stained in a very short period in certain operating environments. If the dome cover lens becomes excessively contaminated, clean it with a lens cleaning cloth (or tissue) moistened with a solution of neutral detergent in water.
- If this camera is stored in an environment with low temperature with its power turned off, a message indicating "PLEASE WAIT. NOW WARMING-UP." will appear blinking on the monitor when the power is turned on, and it will start to warm up. Warming up is complete after the internal parts of the camera reaches an appropriate temperature, after which normal operation of the camera is possible. Please wait for a while until the warming up message disappears.

### ■ Zooming operation

The following phenomena are due to the characteristics of the built-in lens and are not malfunctions.

- Focus may deviate slightly upon stopping a zoom operation near the Tele end manually or using a preset selection.
- Manual zooming operation may not always be smooth.
- When a preset selection is made, the image may go out of focus for a second during the zoom operation.

### ■ Preset positions

- The zooming position of the camera can be set to a total of 100 preset positions, including the home position.

### ■ Note on consumable parts

The following parts are consumable and should be replaced after a certain number of hours or a count of operations. The service lives given below are only typical values. They may vary depending on the operating environment and conditions. Note that the replacement of consumable parts is chargeable even when they are replaced before the termination of the warranty period.

- Zoom lens assembly
- Zooming operation : 2 million times
- Focusing operation : 4 million times
- Slip rings : 5 million operations
- Cooling fan : Approx. 50,000 hours

### ■ Note on auto focusing

Although this unit incorporates a one-push auto-focusing system and EASY AF functions, auto-focusing may sometimes be impossible depending on the object and camera setup. In this case, adjust the focusing manually.

Objects and images with which auto focusing may be difficult:

- When the image brightness is extremely high.
- When the image brightness is extremely low.
- When the image brightness varies continuously (for example when the object is a flashing light).
- When the image contrast (difference between bright and dark) is very poor.
- When the image does not contain a vertical contour component.
- When vertical stripe patterns recur on the screen.

Camera setups with which auto focusing may be difficult:

- When the AGC is activated and the image is coarse.

→ Refer to page 1-13.

## Name and Function of Parts

### ■ Ceiling Mount (Terminal Side)

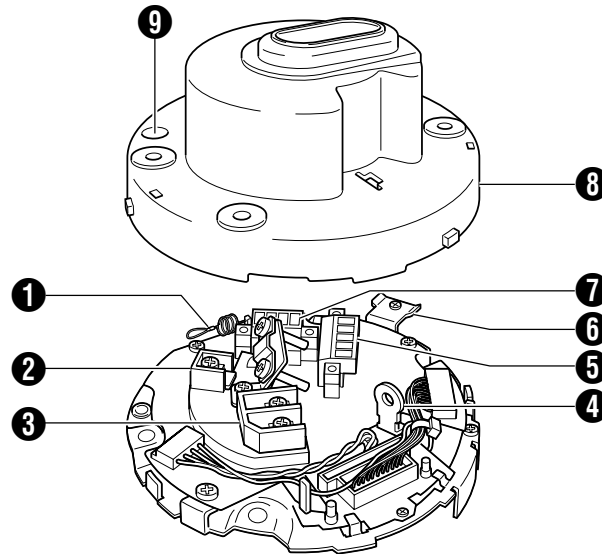

#### 1 Safety Wire

Hang this wire to the Fastening Hook for Safety Wire ⑨.

#### 2 [VIDEO OUT] Coaxial Cable Terminal

Output terminal of a composite video signal (1 V(p-p)) with an output impedance of 75 Ω, to be connected to a switcher, etc.

#### 3 [AC24V ~ INPUT] AC 24 V Input Terminal

Connect to a AC 24 V power supply.

#### 4 Safety Wire Mounting Hole

To prevent the camera from falling down, pass the wire from the ceiling slab or channel to this hole.

#### 5 [ALARM IN / OUT] Alarm Input/Output Terminals (J502)

Terminals for alarm input and output. (☞ pg. 17)

Pin No.	Signal Name	Displayed As
1	Alarm Output +	OUT +
2	Alarm Output -	OUT -
3	Alarm Input	IN
4	GND	GND
5	—	RESERVED

#### 6 Locking Screw

For fastening the camera body. Ensure to fasten the Camera Clamping Bracket ⑩ using this screw.

#### 7 [CONTROL] Control Signal Terminal (J501)

Connect this to the remote control unit (RM-P2580).

Pin No.	Signal Name	Displayed As
1	TX +	Ⓐ
2	TX -	Ⓑ
3	RX +	Ⓒ
4	RX -	Ⓓ

#### 8 Cover

This is a protection cover. Cut a slit in the rubber cap attached to the cover when wiring cables. When connecting cables to the ceiling mount, ensure to do so by running the cables through the Cover ⑧. (☞ pg. 16)

#### 9 Cover Fastening Screw

This is used for fastening the Cover ⑧ and the ceiling mount.

To remove Cover ⑧, do so by unfastening this screw.

## Name and Function of Parts (continued)

### ■ Ceiling Mount (Setting Switch Side)

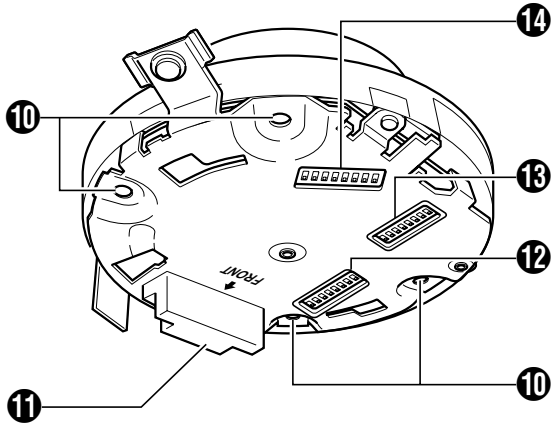

**10 Clamping Hole (x 4)**

Use these holes to attach the camera to the ceiling or ceiling recessed bracket (WB-S625: sold separately).

**11 Camera Connection Terminal (Female)**

Connect this to the Camera Connection Terminal (Male) 15 on the camera.

**12 [Machine ID] Machine ID Setting Switch**

For systems such as RM-P2580 that make use of the RS-485 multi-drop communication system, set the ID for individual cameras. (pg. 14)

**13 Setting Switch**

For performing settings such as PROTOCOL and SYNC. (pg. 13)

**14 Auxiliary Switch**

This switch cannot be used.

### ■ Camera

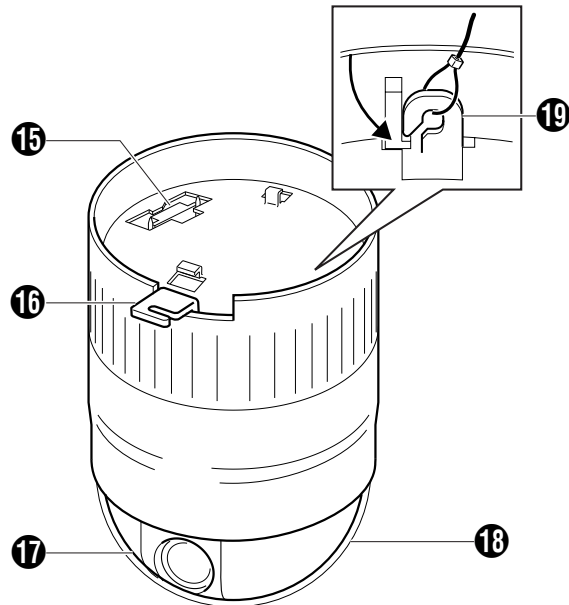

**15 Camera Connection Terminal (Male)**

For connection to the Camera Connection Terminal (Female) 11 on the ceiling mount.

**16 Camera Clamping Bracket**

Insert the Locking Screw 6 into this bracket and tighten to fasten the camera and the ceiling mount.

**17 Lens**

The lens is not a replaceable item.

**18 Dome Cover**

The dome cover is fragile. Take care when handling it.

**19 Fastening Hook for Safety Wire**

Hang the Safety Wire 1 (to prevent camera from falling down) on the ceiling mount to this hook.



# Multi-Drop Communication System

A system that employs the RM-P2580 as the controller.

The following figure shows a system that can accommodate up to eight cameras. (100 positions can be preset per camera.)

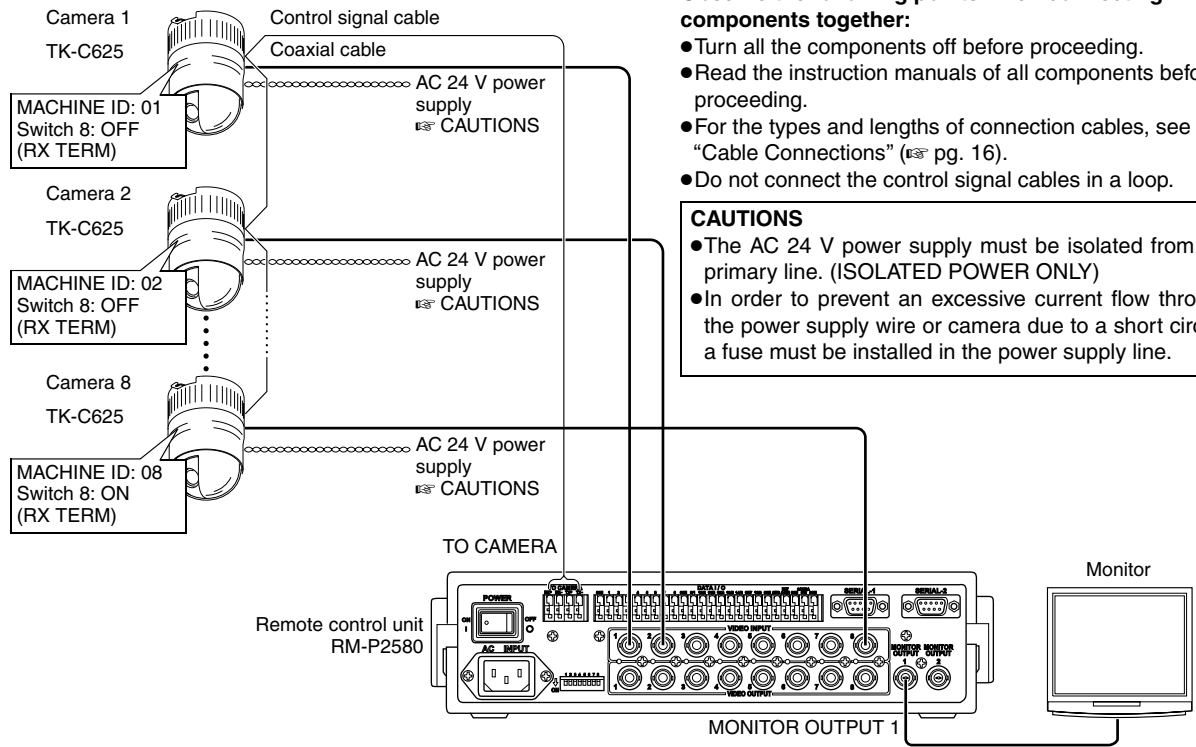

**Observe the following points when connecting components together:**

- Turn all the components off before proceeding.
- Read the instruction manuals of all components before proceeding.
- For the types and lengths of connection cables, see "Cable Connections" (pg. 16).
- Do not connect the control signal cables in a loop.

**CAUTIONS**

- The AC 24 V power supply must be isolated from the primary line. (ISOLATED POWER ONLY)
- In order to prevent an excessive current flow through the power supply wire or camera due to a short circuit, a fuse must be installed in the power supply line.

■ **"Cable Connections"** (pg. 16)  
(Terminal side of Ceiling Mount)

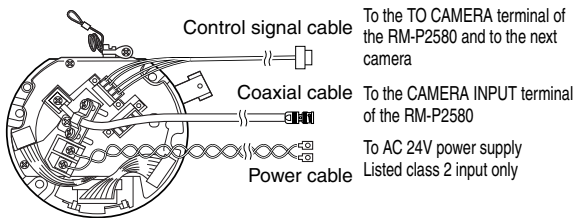

■ **"Switch Settings"** (pg. 13)  
(Setting switches are on the side of the Ceiling Mount)

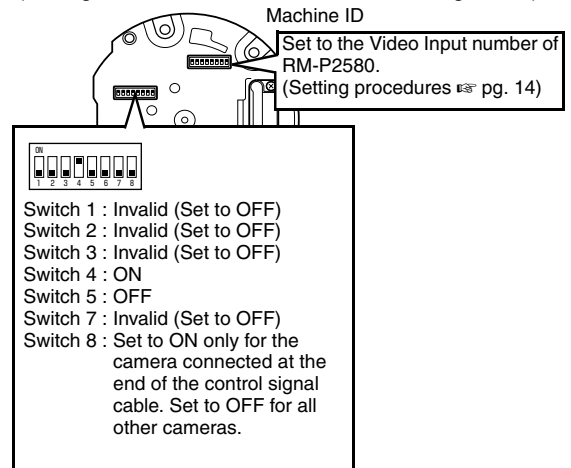

**Connection of the control signal cable**  
(A twisted pair cable is recommended.)

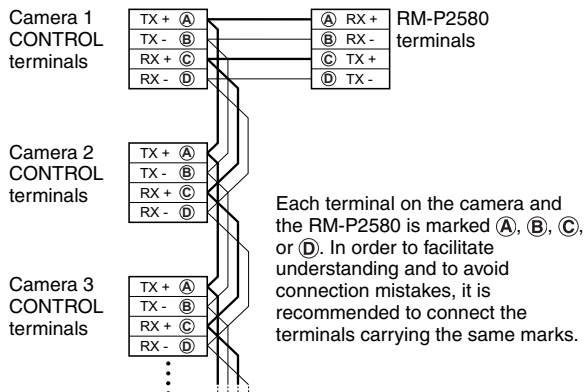

**Camera 1 monitor display at power ON**

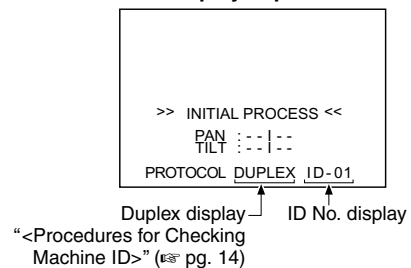

## Multi-Drop Communication System (continued)

A system that does not employ the RM-P2580 as the controller.

### MEMO

- Be sure to terminate the control signal cable at both ends. The cables (length of stub) connecting pieces of non-terminated equipment (cameras or controllers) must be as short as possible. If the length of stub is too long, control precision may suffer.

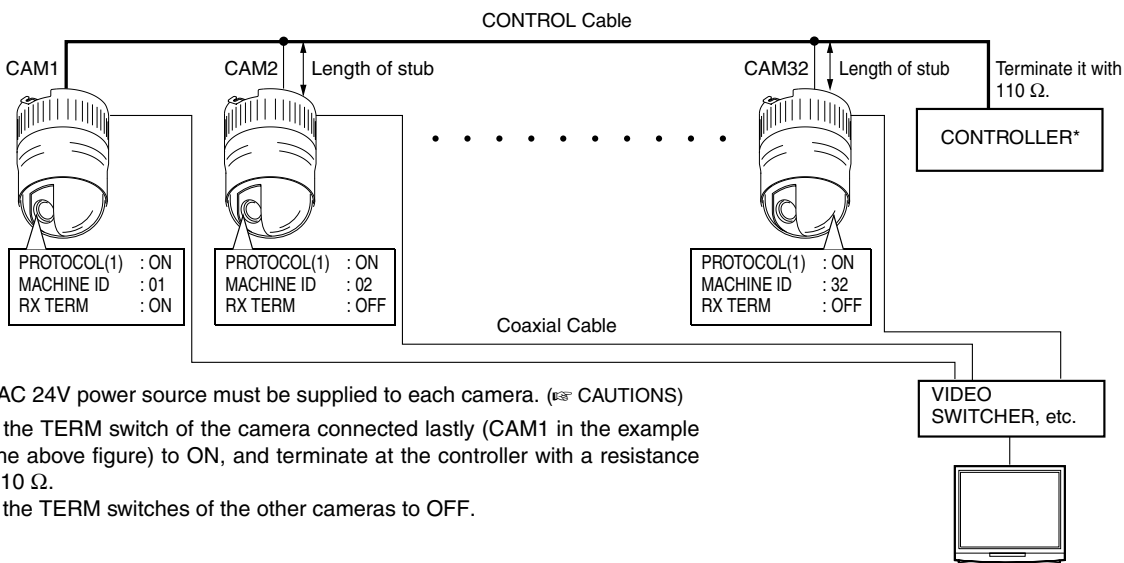

- An AC 24V power source must be supplied to each camera. (⚠ CAUTIONS)
- Set the TERM switch of the camera connected lastly (CAM1 in the example of the above figure) to ON, and terminate at the controller with a resistance of 110 Ω. Set the TERM switches of the other cameras to OFF.

### CAUTIONS

- The AC 24 V power supply must be isolated from the primary line. (ISOLATED POWER ONLY)
- In order to prevent an excessive current flow through the power supply wire or camera due to a short circuit, a fuse must be installed in the power supply line.

## Point-to-Point Communication System

The following illustration shows a system in which a remote control unit (or a similar piece of equipment) controls a single camera.

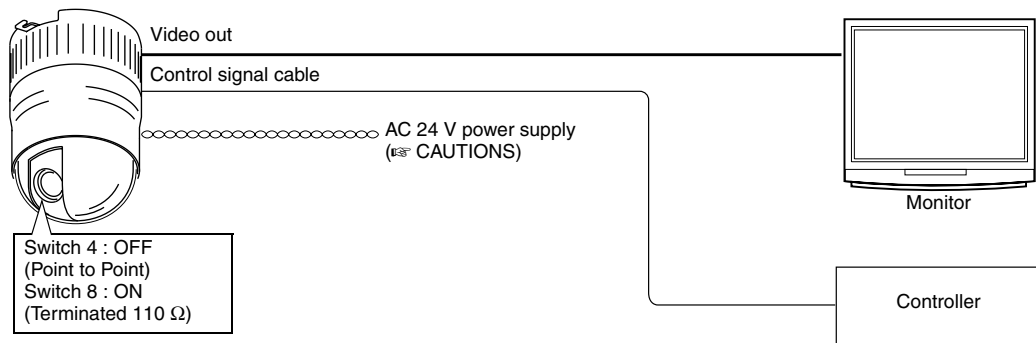

**Observe the following points when connecting components together:**

- Turn all the components off before proceeding.
- Read the instruction manuals of all components before proceeding.

■ **“Cable Connections”** (pg. 16)  
(Terminal side of the Ceiling Mount)

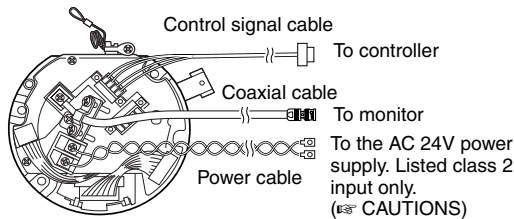

■ **“Switch Settings”** (pg. 13)  
(Setting switches are on the side of the Ceiling Mount)

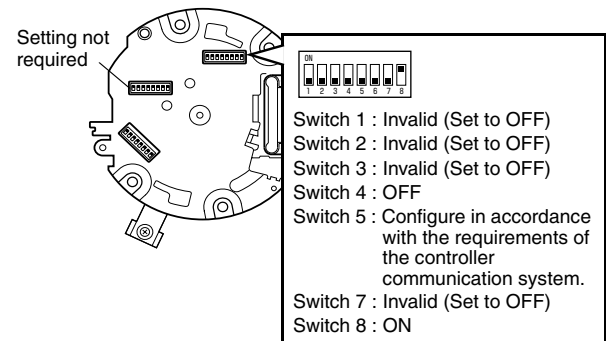

**MEMO**

- If this camera or the cables connected to this camera are used in places subject to strong electromagnetic waves or other forms of magnetism, such as those near a radio or TV transmitter, a power transformer or an electric motor, the picture may suffer from noise and colors may be affected.
- An optionally available controller is required to use a TK-C625 camera. Please contact your local dealer or installer for more information about these controllers.

**CAUTIONS**

- The AC 24 V power supply must be isolated from the primary line. (ISOLATED POWER ONLY)
- In order to prevent an excessive current flow through the power supply wire or camera due to a short circuit, a fuse must be installed in the power supply line.

## Point-to-Point Communication System (continued)

Use twisted-pair cables for the connections.

### •Duplex

When the camera is controlled using the full duplex protocol, set the Switch 5 of the Setting switch to ON.

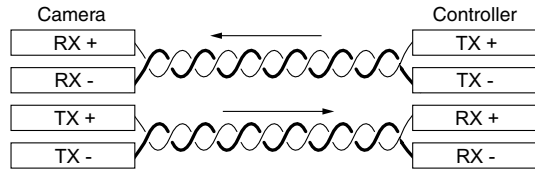

Four wires must be connected.

### Example (connection with an RM-P2580)

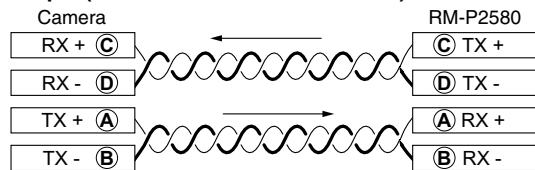

### •Simplex

When the camera is controlled using the simplex transmission protocol, set the Switch 5 of the Setting switch to ON.

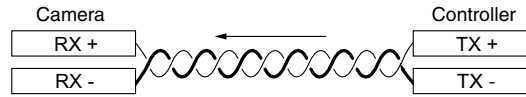

Two wires must be connected.

## Switch Settings

Set the switches on the Ceiling Mount before installing the camera. Settings vary according to configuration of the system used.

### Setting switches

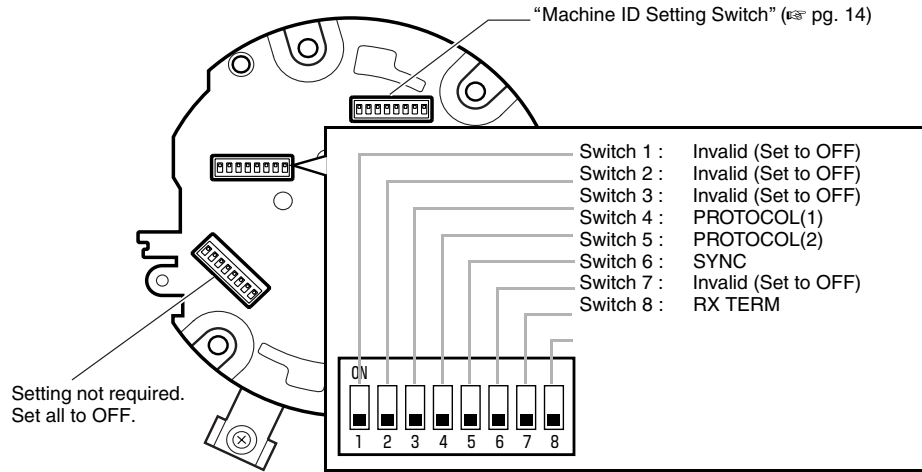

#### RESERVED (Switches 1, 2, 3)

These switches must be set to OFF.

#### PROTOCOL (1) (Switch 4)

Selects whether a single camera or multiple cameras are controlled in a system.

Set PROTOCOL(1) to Multi drop when connecting multiple cameras in series.

PROTOCOL (1)	Switch 4	
Point-to-point	<input type="checkbox"/>	OFF
Multi-drop (when using the RM-P2580)	<input type="checkbox"/>	ON

(Initial setting: OFF)

When set to Multi-drop, be sure to set the Machine ID of each camera.

#### PROTOCOL (2) (Switch 5)

Set this switch according to the communication protocol used when controlling the cameras.

PROTOCOL (2)	Switch 5	
Duplex (when using the RM-P2580)	<input type="checkbox"/>	OFF
Simplex	<input type="checkbox"/>	ON

(Initial setting: OFF)

#### SYNC (Switch 6)

When this switch is set to ON, the vertical sync of the camera becomes locked to the frequency of the AC power line.

SYNC	Switch 6	
INT	<input type="checkbox"/>	OFF
LL	<input type="checkbox"/>	ON

(Initial setting: OFF)

(LL mode : TK-C625E : 50Hz ONLY  
TK-C625U : 60Hz ONLY)

#### RESERVED (Switch 7)

This switch must be set to OFF.

#### RX TERM (Switch 8)

This switch sets whether or not the section between control signal terminals RX + and RX - is to be terminated (with a resistance of 110 Ω).

RX Termination	Switch 8	
Terminated (110 Ω)	<input type="checkbox"/>	ON
Open	<input type="checkbox"/>	OFF

(Initial setting: Terminated (110 Ω))

When the system in which this camera is used is a multidrop system (RS-485 system), set only the camera located at the extreme end of the control signal cables to “Terminated” and set the other cameras to “Open”.

## Switch Settings (continued)

### ■ Machine ID Setting Switch

When controlling the system using a multi-drop remote control unit such as RM-P2580, for instance, assign a number (machine ID) for identification to each of the connected cameras.

Assign a machine ID according to the video input number of RM-P2580.

### ● Ceiling Mount (Setting Switch Side)

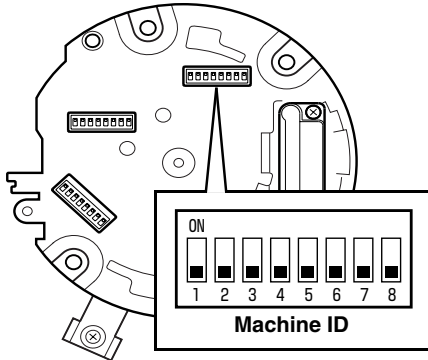

### <Procedures for Checking Machine ID>

**1** Output video image for checking to the monitor

**2** Turn on the power (AC 24 V) of the camera

**3** Camera initializes

The following message will appear.

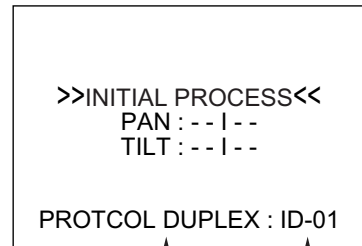

Check that this is displayed as "DUPLEX"

Displayed as ID-□□. Check that the number □□ is correct.

**4** Check to ensure that "DUPLEX" and "ID-□□" are displayed, and whether the number coincides with the video input number of RM-P2580. If the number is incorrect, re-set the machine ID.

### MEMO

- For systems using RM-P2580, a set of control signal cables are connected to multiple cameras during use. Errors in the switch setting of any one of the cameras will therefore cause malfunction in the entire system.

■ Machine ID

Set the Machine ID using a combination of numbers between 1 to 8. (This is set to OFF in the factory settings.)

Machine ID	Machine ID Installation Switch	Machine ID	Machine ID Installation Switch	Machine ID	Machine ID Installation Switch	Machine ID	Machine ID Installation Switch
1		27		53		79	
2		28		54		80	
3		29		55		81	
4		30		56		82	
5		31		57		83	
6		32		58		84	
7		33		59		85	
8		34		60		86	
9		35		61		87	
10		36		62		88	
11		37		63		89	
12		38		64		90	
13		39		65		91	
14		40		66		92	
15		41		67		93	
16		42		68		94	
17		43		69		95	
18		44		70		96	
19		45		71		97	
20		46		72		98	
21		47		73		99	
22		48		74			
23		49		75			
24		50		76			
25		51		77			
26		52		78			

## Cable Connections

### CAUTIONS

- Ensure to attach the cover for the ceiling mount. Installation is not possible without attaching the cover.
- The cover prevents penetration of foreign objects into the ceiling mount. Penetration of foreign objects may cause a malfunction or, in the worst scenario, cause smoking or fire.

### Connection Procedure

#### 1 Make a hole in the ceiling

Make use of the template supplied to open a hole ( $\phi 75$ ) for leading the connection cable through the rear side of the ceiling.



#### 2 Remove the Cover

Loosen the Cover Fastening Screw, and turn the Cover in the anti-clockwise direction to remove the Cover from the ceiling mount.

### MEMO

- When loosening the Cover Fastening Screw, do so while ensuring that it does not protrude from the hole.

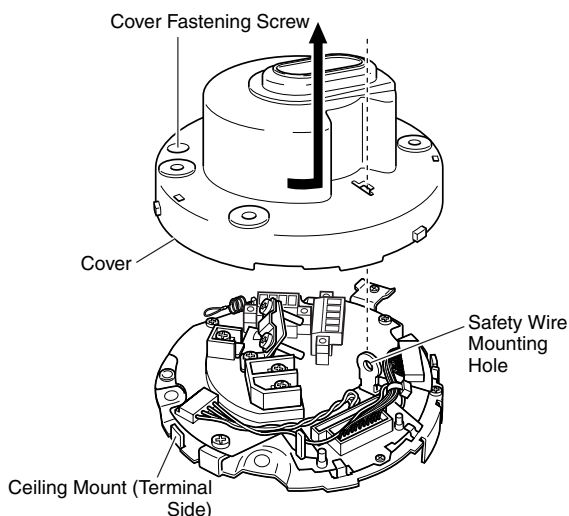

#### 3 Lead the cable through the Cover

Make a slit on the (rubber) cap that is attached to the Cover, followed by leading the cable through. Follow the diagram below to make the slit.

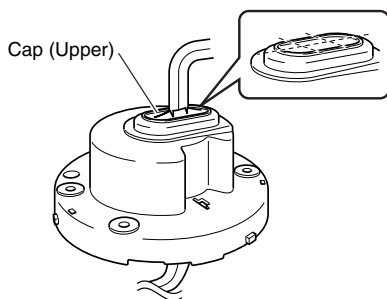

#### 4 Connect the cable to this camera

Connect cables to the terminal on the ceiling mount. Connection cables include alarm signal cable, coaxial cable, control signal cable and the AC 24 V power cable.

- 1 **Control Signal Cable** (see pg. 18)  
For connection to RM-P2580.
- 2 **Coaxial cable** (see pg. 17)  
For connection of monitors and other devices.
- 3 **Alarm signal cable** (see pg. 17)  
For connection to devices with alarm input/output terminals.
- 4 **Power cable** (see pg. 18)  
For connection to an AC 24 V power supply. Listed class 2 input only.

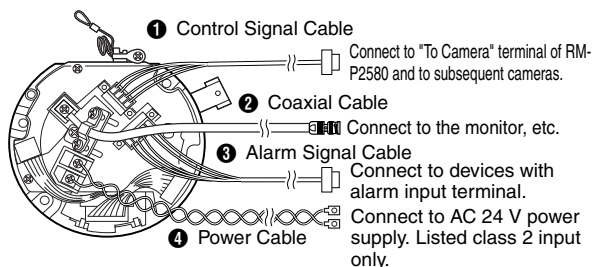

#### 5 Attach the Cover

Attach the Cover to the ceiling mount by following procedure of Step 2 in the reverse order.

- 1 Attach the cover upon aligning the hole with the Safety Wire Mounting Hole on the ceiling mount, followed by turning it in the clockwise direction.
- 2 Fasten the Cover Fastening Screw.



### Connection of Alarm Input / Output Terminals

Connect the alarm input/output terminals to external devices such as sensors and buzzers.

- ❶ Follow the diagram below to loosen and remove the screws on the two edges of the terminal block.
- ❷ Strip the coating of the alarm signal cable by about 4 mm before inserting it into the terminal.
- ❸ Turn the screw on the side to fasten the alarm signal cable.
- ❹ Upon fastening the alarm signal cable, re-install the terminal block that has been dismantled in ❶.

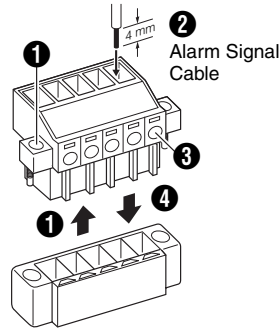

#### ■ Alarm Input Terminal

Connect this terminal to an infrared, door or metallic sensor, or to a manual switch.

- Input non-voltage contact signal to the alarm input terminal to prevent internal circuit noises.
- Do not supply voltage.
- Use the menu to set whether to activate alarm when the contact is short (make) or open (break).
- Ensure that the alarm signal input lasts for at least 200 ms. Otherwise, they may not be recognized as alarm signals.

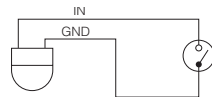

#### ■ Alarm Output Terminal

Connect this to alarm devices such as an annunciator, indicator, lamp or buzzer.

- The alarm output terminal is a photocoupler-insulated open collector, which turns ON during an alarm.
- As these terminals are provided with polarity. Ensure that voltage at the + terminal is higher than that at the - terminal. Application of reverse voltage in this case may cause the device to break down.

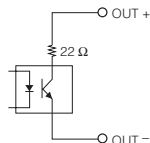

**Rating**  
 Maximum applied voltage : 20 V DC  
 Maximum drive current : 25 mA

### Connection of Coaxial Cables

Connecting an RG-59 coaxial cable.

Strip the tip of the coaxial cable according to the diagram below.

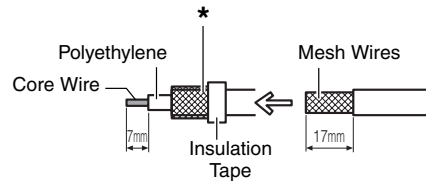

\*Fold back the mesh wires and secure using an insulation tape to prevent them from becoming loose and causing a short circuit.

#### MEMO

- If an RG-11 coaxial cable is used it cannot be connected directly to the terminal board. To use such a cable, connect an RG-59 cable to the camera and then connect the RG-11 cable to the RG-59 cable.
- To increase cable extension, make use of thicker cables or a cable compensator.
- The maximum extension distance varies according to the system in use as well as characteristics of the cable.

## Cable Connections (continued)

### Connection of Control Signal Cables

Connect this to the remote control unit (RM-P2580).

The maximum permissible length of the control signal cable during connection with RM-P2580 is 1200m. (RM-P2580 allows connection of a set of cables to multiple cameras. In this case, the total length of the cables shall not exceed 1200m.)

- 1 Follow the diagram below to loosen and remove the screws on the two edges of the terminal block.
- 2 Strip the coating of the control signal cable by about 4 mm before inserting it into the terminal.
- 3 Turn the screw on the side to fasten the control signal cable.
- 4 Upon fastening the control signal cable, re-install the terminal block that has been dismantled in 1.

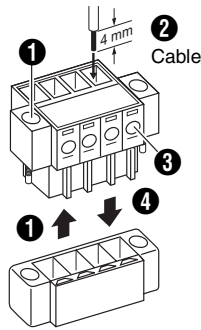

#### MEMO

- Instead of using 0.65, 4-core cables (2 pairs), it is recommended that twisted pair cables (category 3 and above) for use with Ethernet be used.
- Cables with a thickness between 0.4 mm to 1.3 mm can be used.
- Connect the control signal cables so that TX+ and TX- form a pair and RX+ and RX- form another.

To reduce the radiation of the Control Signal Cables connecting to this unit, make sure to mount the provided Ferrite Core.

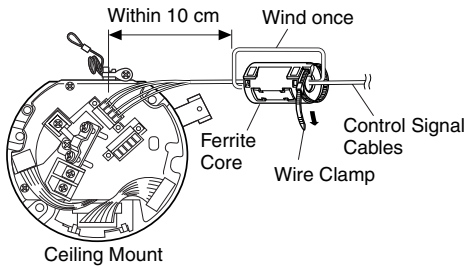

- CAUTIONS**

  - Mount the Ferrite Core as close as possible the camera (within 10 cm).
  - Secure the Ferrite Core with the provided Wire Clamp.
  - Pass the wire through the Ferrite Core once before connecting to the camera.

### Connection of Power

Connect to an AC 24 V Supply.

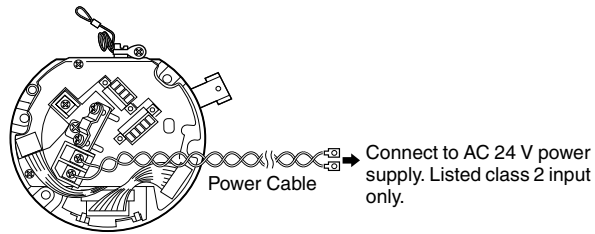

Connect the AC 24 V power cable to the AC 24 V input terminal of the terminal block. When doing so, use of a lug plate is recommended for connection to the AC 24 V terminal to prevent connection errors and disconnection of cables.



When a 2-conductor VVF (vinyl-insulated vinyl sheath cable) is used, the maximum connection lengths are as follows. (Reference values)

Maximum Connection Length	100 m	260 m	410 m	500 m
Conductor Diameter	ø1.2 or more	ø1.8 or more	ø2.3 or more	ø2.9 or more

#### CAUTIONS

- When thin cables are used, the cable resistance increases. As a result, the effective voltage will drop when the power consumption of the unit is at its maximum level (during simultaneous operation of panning and tilting). As such, use thicker cables with lower resistance, or decrease the cable length by installing the power supply unit near the camera, such that voltage drop upon flow of the rated current of the camera does not exceed 10%. When the voltage drops while the camera is in use, performance may become unstable and preset positions may not be reproduced accurately.
- The internal circuit may be damaged if the cable is connected by mistake. In this case, ensure that you stop using and contact the nearest JVC dealers.

## Installing the Ceiling Mount

### CAUTIONS

- Attachment of a recessed cover in the ceiling (recess bracket) may be mandatory in certain regions. If this is so, ensure that the recessed cover (recess bracket) is securely attached before installing the camera.
- Please refer to the instruction manual of the cover in use for details on installation of the recessed cover (recess bracket).
- For more detail, please contact the JVC dealers.

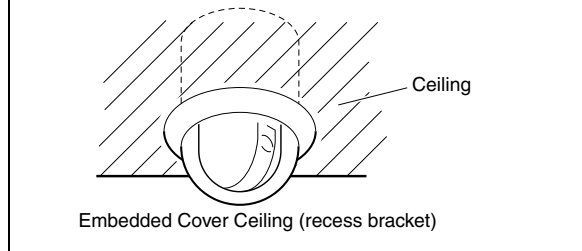

### 1 Attach the Safety Wire

Connect the ceiling slab or channel to the ceiling mount using a safety wire to prevent the camera from falling down. Make use of the Safety Wire Mounting Hole to connect the ceiling mount and the wire. (Refer to diagram below.)

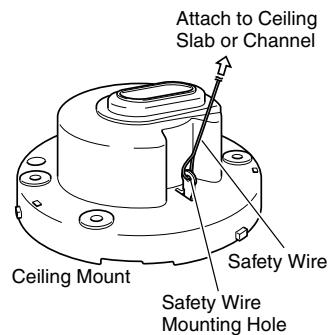

### CAUTION

Choose a wire and ceiling structure with an appropriate length and strength that may prevent danger in case the camera falls down.

### MEMO

- Connect the wire in such a way that it can be insulated from the ceiling structure. If the ceiling structure is made of a metallic material, improper insulation with the camera may cause noise interference in the images.
- Safety wires are not provided. Please purchase commercially available wires separately.

### 2 Fasten the ceiling mount to the ceiling

Align the "↑FRONT mark" to the front direction that the camera is facing, and fasten the ceiling mount to the ceiling using the 4 screws while paying attention not to catch the connection cables.

Use M4-sized (No 8) screws or bolts. For woodscrews, make use of those with a diameter of 4.1 mm.

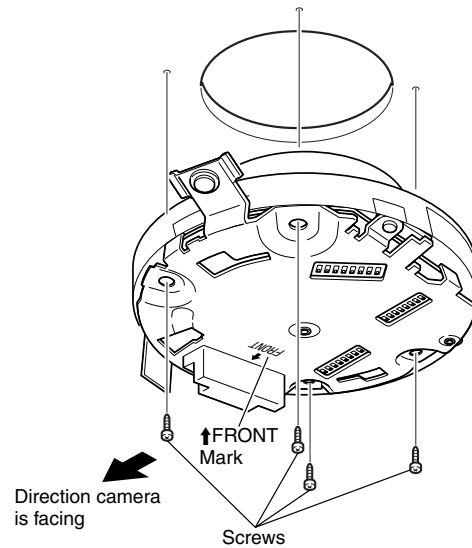

### MEMO

- Be sure to use 4 screws and attach them firmly.
- The sheet attached to the ceiling-mount screw holes of the ceiling mount acts as an insulator between the ceiling mount and the ceiling structure. If the ceiling structure is made of a metallic material, improper insulation with the camera may cause noise interference in the images. To prevent this from occurring, ensure proper insulation during installation.

## Installing the Camera

### 1 Attach the Safety Wire

Follow the diagram to pull out the Safety Wire from the ceiling mount, followed by hanging it to the Fastening Hook for Safety Wire on the camera.

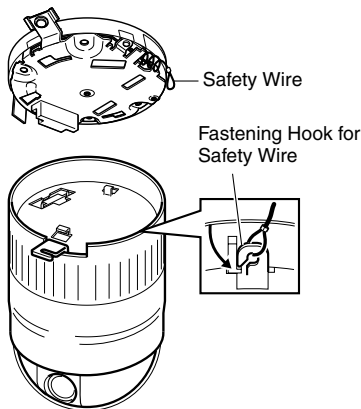

### CAUTION

- Be sure to connect the Safety Wire. Otherwise, the camera may fall to the ground.
- Do not leave the camera hanging from the Safety Wire. The spring of the Safety Wire may lose its elasticity, and wire may get caught, thus preventing the camera to fit properly to the ceiling mount.

### 2 Check that the Locking Screw is loosened

The camera cannot be properly installed if the Locking Screw of the ceiling mount is not loosened.

### 3 Fit the camera to the ceiling mount

Fit the camera to the ceiling mount by aligning the "△ mark" of the camera with the "▽ mark" of the ceiling mount. Additionally, check the positions of the Camera Clamping Bracket and the Locking Screw of the ceiling mount before fitting the camera.

#### Ceiling Mount

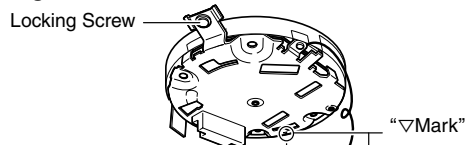

#### Camera

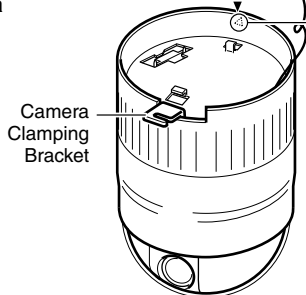

### 4 Turn the camera

Make sure that the camera is not tilted, followed by pushing the camera against the ceiling mount and turning it in the clockwise direction until it stops. Upon doing so, check that the Camera Clamping Bracket is aligned with the position of the Locking Screw of the ceiling mount.

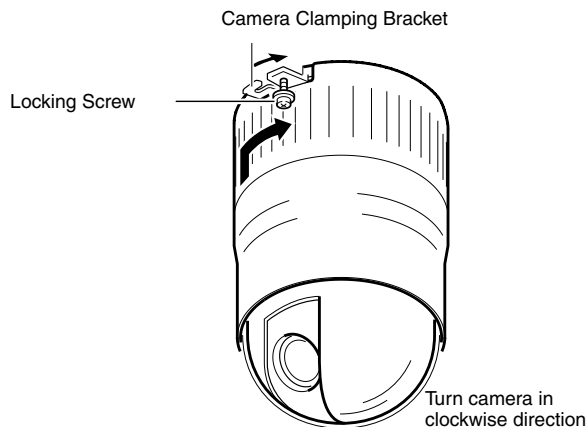

### 5 Fasten the Locking Screw

Fasten the Locking Screw using a Phillips-head screwdriver.

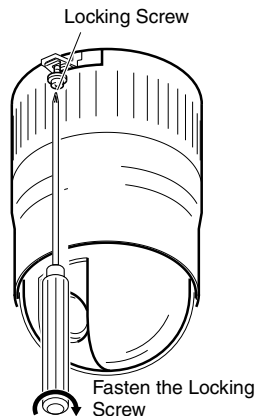

### CAUTION

If the Locking Screw is not securely fastened, the camera may vibrate or fall down. Be sure to fasten the Locking Screw firmly.

- To dismantle the camera, perform procedure from **1** to **5** in the reverse order.

# Setup Procedure

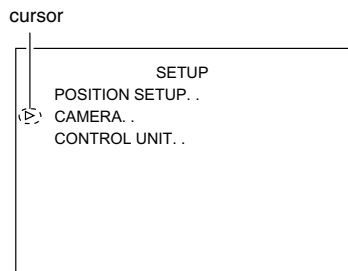
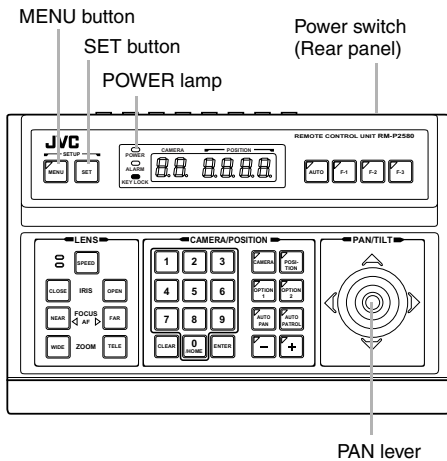

SETUP menu of the remote control unit

Indication of presence of submenus

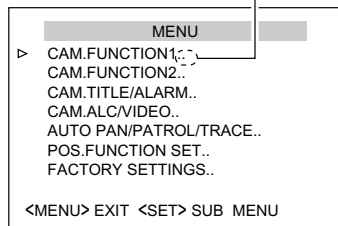

MENU screen for the camera

Change mark

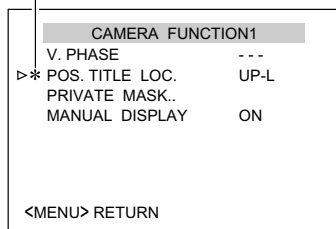

Example of a submenu

In systems using an RM-P2580 remote control unit, the menus for use during camera setup can be displayed on the remote control unit. (Please refer to the Instructions for RM-P2580.)

## ■ Setting the camera menus from RM-P2580

### 1 Set the Power switch on the rear panel of the RM-P2580 to ON.

- The POWER lamp lights up.

### 2 Press and hold the MENU button for 3 seconds.

- The LED of the MENU button lights up.
- The "SETUP" menu of the remote control unit is displayed on the monitor connected to MONITOR OUTPUT 1.

### 3 Move the PAN lever downward to move the cursor (▷) to "CAMERA.." in the menu.

- Tilting the lever upward (▲) moves the cursor upward.
- Tilting the lever downward (▼) moves the cursor downward.

### 4 Press the SET button.

- The "MENU" screen for the camera is displayed.
- Items followed by ".." have further submenus.

### 5 Tilt the PAN lever up or down to select an item.

### 6 Tilt the PAN lever to the left or right to change the value of the item.

- Tilting the lever toward the left (◀) decreases the value.
- Tilting the lever toward the right (▶) increases the value.

Upon changing the set value of items, a change mark (\*) will appear as indicated in the left diagram. Please refer to the following pages for details on setting of the sub-menu.

### 7 Press the MENU button.

After completing the setup of the menu items, press the MENU button to return to the previous menu screen.

## MEMO

- To prevent malfunction of the camera, do not perform menu operation until initialization of the camera has completed.

# Menu Screen Configuration

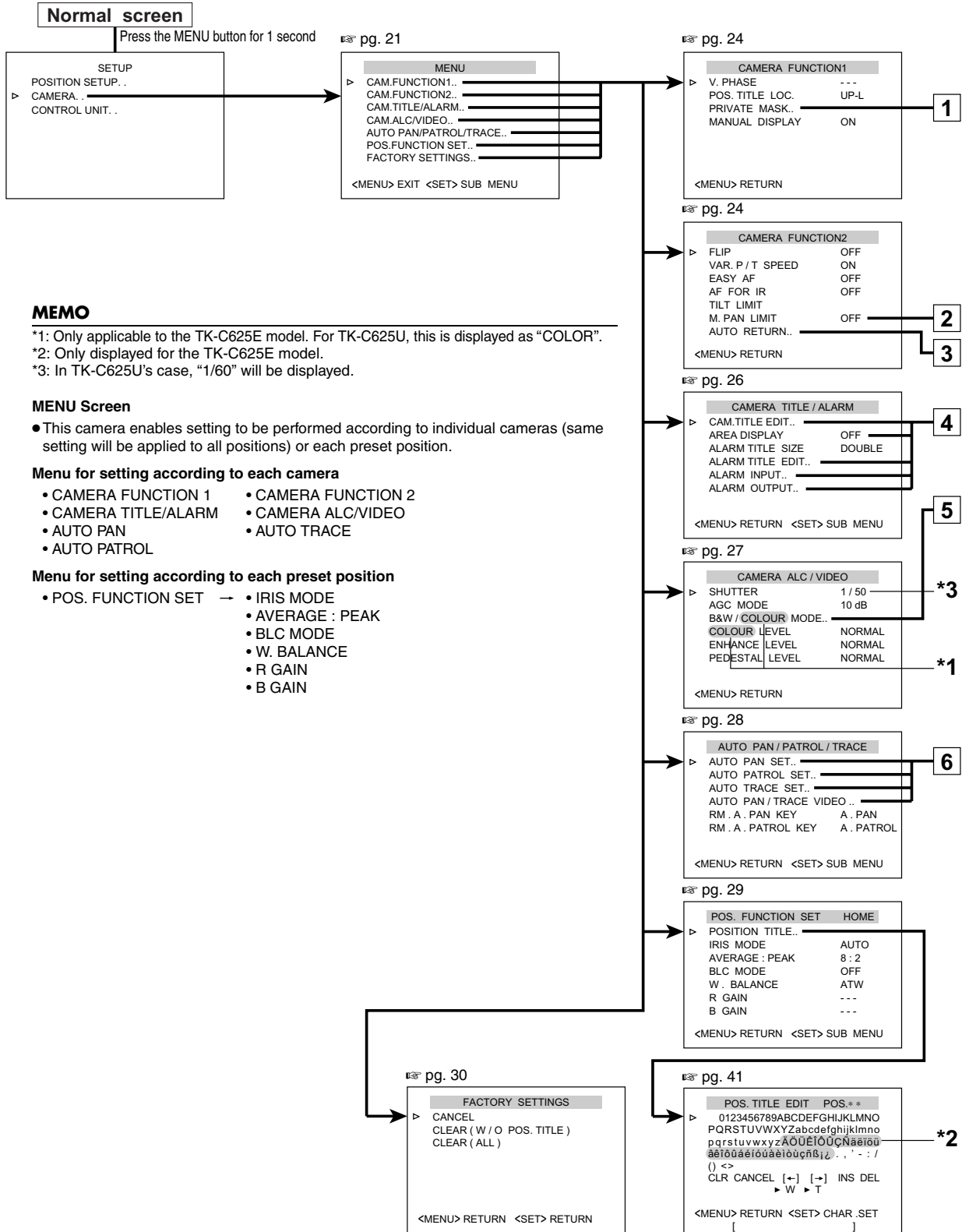

**MEMO**

- \*1: Only applicable to the TK-C625E model. For TK-C625U, this is displayed as "COLOR".
- \*2: Only displayed for the TK-C625E model.
- \*3: In TK-C625U's case, "1/60" will be displayed.

**MENU Screen**

• This camera enables setting to be performed according to individual cameras (same setting will be applied to all positions) or each preset position.

**Menu for setting according to each camera**

- CAMERA FUNCTION 1
- CAMERA FUNCTION 2
- CAMERA TITLE/ALARM
- CAMERA ALC/VIDEO
- AUTO PAN
- AUTO TRACE
- AUTO PATROL

**Menu for setting according to each preset position**

- POS. FUNCTION SET →
- IRIS MODE
- AVERAGE : PEAK
- BLC MODE
- W. BALANCE
- R GAIN
- B GAIN

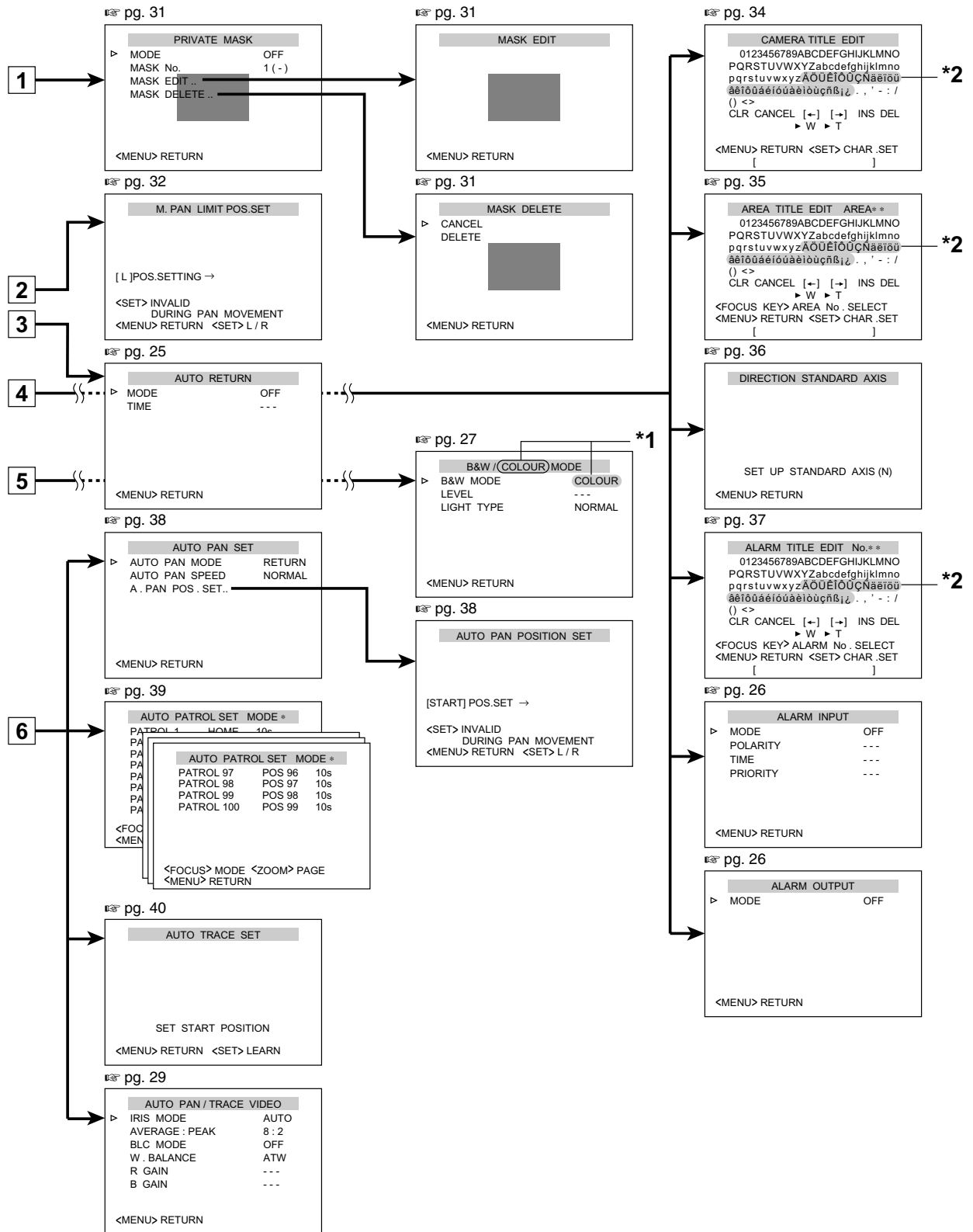

**MEMO**

\*1: Only applicable to the TK-C625E model. For TK-C625U, this is displayed as "COLOR".  
 \*2: Only displayed for the TK-C625E model.

## CAMERA FUNCTION 1 Screen

Item	Function/Set Value	Initial Value
<b>V. PHASE</b>	This adjusts the vertical synchronization to those of other cameras when a selector switch for the synchronizing system on the Ceiling Mount is at LL. (50 Hz *(60Hz) power region only.) *( ) : TK-C625U Set values : TK-C625E : -156 to 0 to 156 TK-C625U : -131 to 0 to 131	0
<b>POS.TITLE LOC.</b>	Use this to set the display positions of position and area titles. UP-L : Display at the top left of the screen. DOWN-C : Display at the lower center of the screen. DOWN-L : Display at the bottom left of the screen. UP-R : Display at the top right of the screen. UP-C : Display at the upper center of the screen. DOWN-R : Display at the bottom right of the screen. [Set values: UP-L, DOWN-L, UP-C, DOWN-C, UP-R, DOWN-R]	UP-L
<b>PRIVATE MASK..</b>	This function grays out sections on the captured image that are not to be displayed. The grayed out section moves accordingly during panning, tilting and zooming. "PRIVATE MASK Setup" (pg. 31)	—
<b>MANUAL DISPLAY</b>	Use this to set whether to display "MANUAL" on the screen when manual operation is performed at non-preset positions using the remote control unit. When this is set to "ON", "AUTO PAN" and "AUTO TRACE" will also be displayed on the screen respectively during Auto Pan and Auto Trace operations, in addition to manual operation. ON : Display "MANUAL". OFF : Do not display "MANUAL".  <b>MEMO</b> • Even when this item is set to "ON", display will not appear when the "AREA DISPLAY" (pg. 26) item is set to "TITLE" or "DIR", or when a preset position is selected.	ON

## CAMERA FUNCTION 2 Screen

Item	Function/Set Value	Initial Value
<b>FLIP</b>	When Tilt operation is performed with this item set to "OFF", the camera will stop at the position where it is facing directly downwards. When an object passes beneath the camera, the camera will ① point downwards, ② pan 180°, and ③ point upwards. In other words, the camera needs to perform these 3 steps. By using the Auto Flip function helps to reduce the number of operations. Set this function when shooting an object that passes beneath the camera. OFF : Auto Flip is disabled. AUTO 1 : The camera pans 180° automatically and stops when the object comes beneath the camera. In this case, the camera and PAN/TILT lever operations function in the same direction. AUTO 2 : The camera pans 180° automatically when the object comes beneath the camera, and direction of the camera and TILT lever operations function in opposite directions. Set this function to enable continuous operation. Stopping this operation restores the camera to its normal direction of operation. AUTO 3 : The camera pans 180° automatically when the object comes beneath the camera, and direction of the camera and TILT lever operations function in opposite directions. The camera will return to its normal direction of operation upon a lapse of 10 seconds or more after the operation stops.	OFF
<b>VAR. P/T SPEED</b>	Use this to alter the Pan (horizontal) and Tilt (vertical) speed automatically according to the zoom of the lens. Pan and Tilt speed will slow down when the zoom lens is set to TELE, and speeds up when set to Wide. Set this when shooting objects with a different zoom ratio. OFF : Disabled. ON : Enabled.	ON
<b>EASY AF</b>	When this is set to ON, the auto focus (AF) function will be automatically activated during manual Pan, Tilt or Zoom operation. This function is convenient when frequent manual operations are expected as it eliminates the need to adjust focus after every manual operation of the camera. OFF : Disabled. ON : Enabled.  <b>MEMO</b> • Auto focusing may sometimes fail to bring an object into accurate focus. (pg. 6) In this case, adjust focus manually.	OFF



Item	Function/Set Value	Initial Value
<b>AF FOR IR</b>	When in the B&W mode, this camera is sensitive to both visible and near-IR lights. As such, images may become out of focus upon switching from the Color to B&W mode, depending on the type of light source used. Set to ON in this case to adjust focus automatically. OFF : Disabled. ON : Enabled.	OFF
<b>TILT LIMIT</b>	Use this to set the range of Tilt (vertical) operation during manual operation. Setting this will not affect preset positions or Auto Trace and Auto Patrol operations. When this is set to 10°, the tilt range will be between 10° and 90°, and operation between 0° and 9° will be disabled. [Set values: OFF, 1° to 10°]  <b>MEMO</b> ● When the camera is moved by an operation that overrides the Tilt Limit into a region outside the tilt range, the camera will function as follows when a manual Tilt operation is performed. • Tilt operations can be freely performed outside the tilt range until the camera enters the valid range again. • Upon entering the valid range, Tilt operation will only be possible within the Tilt Limit that has been set.	5°
<b>M. PAN LIMIT..</b>	Use this to set the range of Pan (horizontal) operation during manual operation. Setting this will not affect preset positions or Auto Pan, Auto Trace and Auto Patrol operations. “MANUAL PAN LIMIT Setup” (pg. 32) [Set values: OFF, ON]	OFF
<b>AUTO RETURN..</b>	Camera will be automatically restored to the mode as set in “MODE” if manual operation of the camera is not performed over the interval as specified in “TIME”.  <b>■ CAUTION</b> This feature will not function properly if the model name on the serial number plate of RM-P2580 is not stated as an RM-P2580(A) product.	
<b>MODE</b>	This is used to set the action upon Auto Return. OFF : Do not perform Auto Return. HOME : Return to home position. A. PAN KEY : Restores action set by the “RM. A. PAN KEY”. (pg. 29) A. PATROL KEY : Restores action set by the “RM. A. PATROL KEY”. (pg. 29)  <b>MEMO</b> ● When using this feature, set the DIP SW4 at the back of RM-P2580 to “ON”.	OFF
<b>TIME</b>	Use this to set the time interval before performing Auto Return. [Set values: 1 min, 2 min, 3 min, 5 min, 10 min, 20 min, 30 min, 60 min]  <b>MEMO</b> ● This item will be displayed as “- -” when the “MODE” item is set to “OFF” and setting is not possible.	1 min

## CAMERA TITLE/ALARM Screen

Item	Function/Set Value	Initial Value
<b>CAM. TITLE EDIT..</b>	Use this to specify the title that is always displayed at the bottom left of the screen. Specify up to a maximum of 16 characters. "CAMERA TITLE Setup" (pg. 34)	—
<b>AREA DISPLAY</b>	Use this to perform area setting. "AREA DISPLAY Setup (TITLE)" (pg. 35) "AREA DISPLAY Setup (DIRECTION)" (pg. 36)	OFF
<b>OFF</b>	Not displayed.	—
<b>TITLE</b>	Equally divides the 360° panning range into 16 areas, and a title of up to 16 characters can be specified for each area. The corresponding area title specified will be displayed upon panning the camera manually. "AREA DISPLAY Setup (TITLE)" (pg. 35)	
<b>DIR</b>	Set N (North), which is the direction of the standard axis. When the camera is panned manually, the 360° panning range will be equally divided into 8 areas, each indicated by N, NE, E, SE, S, SW, W and NW respectively. "AREA DISPLAY Setup (DIRECTION)" (pg. 36)	
<b>ALARM TITLE SIZE</b>	Use this to set the size of the title during an alarm. NORMAL: Same size as characters on the menu screen. DOUBLE: Double the size, both vertically and horizontally, of the characters on the menu screen.	DOUBLE
<b>ALARM TITLE EDIT..</b>	This is a screen for setting the title during an alarm. "ALARM TITLE Setup" (pg. 37)	—
<b>ALARM INPUT..</b>	These items are used to perform setting related to the alarm input terminals.	
<b>MODE</b>	For selecting the mode of the camera for which images are to be output when there is an alarm input. OFF : Does not output images even when there is an alarm input. HOME : Output images at the home position during an alarm input. POS1-99 : Output images at a selected preset position during an alarm input.  <b>MEMO</b> ● Setting the "B&W MODE" (pg. 27) item to "ALARM IN" switches the mode to the B&W mode and setting cannot be changed.	OFF
<b>POLARITY</b>	For setting the polarity of alarm input signals. MAKE : Input alarm signals when the contact between each alarm input terminal and the GND terminal changes from open to closed. BREAK : Input alarm signals when the contact between each alarm input terminal and the GND terminal changes from closed to open.  <b>MEMO</b> ● This item will be displayed as "-" when the "MODE" item is set to "OFF" and setting is not possible.	MAKE
<b>TIME</b>	Use this to set the duration of alarm signal output as well as alarm title display when there is an alarm. [Set values: 5 s, 6 s, 7 s, 8 s, 9 s, 10 s, 15 s, 20 s, 30 s, 60 s]  ■ <b>CAUTION</b> For RM-P2580 systems, this setting is disabled. Set using the Alarm Time item of RM-P2580. (RM-P2580 "INSTRUCTIONS")  <b>MEMO</b> ● This item will be displayed as "-" when the "MODE" item is set to "OFF" or when the "B&W MODE" (pg. 27) item is set to "ALARM IN". In both cases, setting will not be possible.	5 s
<b>PRIORITY</b>	Sets whether or not manual operation is accepted in case an alarm input is recognized during manual operation of the camera. ALARM : Manual operation is not accepted when there is an alarm input. (Priority given to alarm) MANUAL : Manual operation is accepted even when there is an alarm input. (Priority given to manual)  ■ <b>CAUTION</b> This item is invalid with a system using the RM-P2580. With this system, the ALARM input will permanently override manual operation.	ALARM
<b>ALARM OUTPUT..</b>	Use this to perform setting related to the alarm output terminal. OFF : Do not output alarm. ALARM : Output alarm signals when there is an alarm input. B&W : Output alarm signals when the camera switches to the B&W mode. PRESET : Output alarm signals when the camera moves to a preset position. AUX 1 to AUX 3 : Output alarm signals when there is an auxiliary input.	OFF

## CAMERA ALC/VIDEO Screen

This screen enables automatic adjustment according to the brightness. Setting can be performed for the camera video signals, such as color level and contour enhancement.

Item	Function/Set Value	Initial Value
<b>SHUTTER</b>	<p>Sets the speed of the electronic shutter.</p> <p><b>Set Values</b> TK-C625E : 1/50, 1/120, 1/250, 1/500, 1/1000, 1/2000, 1/4000, 1/10000 TK-C625U : 1/60, 1/100, 1/250, 1/500, 1/1000, 1/2000, 1/4000, 1/10000</p> <p><b>MEMO</b></p> <ul style="list-style-type: none"> <li>● To reduce flickering that occurs under fluorescent lighting, set the shutter speed to 1/100 if your local power supply frequency is 50 Hz (TK-C625U), and to 1/120 if it is 60 Hz (TK-C625E).</li> <li>● The higher the shutter speed, the more prominent will be the smear phenomenon. This is a phenomenon that is characteristic of CCD, whereby white stripes appear at the top and bottom of a bright light source.</li> </ul>	<p>TK-C625E: 1/50</p> <p>TK-C625U: 1/60</p>
<b>AGC MODE</b>	<p>Sets the maximum gain of the AGC (Auto Gain Control), which electronically increases the gain when the object is under low light conditions.</p> <p>OFF : Disable AGC. 10 dB : Increase gain by a maximum of 10 dB according to the brightness of the object. 20 dB : Increase gain by a maximum of 20 dB according to the brightness of the object.</p> <p><b>MEMO</b></p> <ul style="list-style-type: none"> <li>● When the "B&amp;W MODE" item is set to "AUTO", the "AGC MODE" item will be automatically set to "20 dB", and set values cannot be changed.</li> <li>● The screen may appear grainy at dark places when the gain level is increased.</li> </ul>	10 dB
<b>B&amp;W/COLOUR MODE..(TK-C625E) B&amp;W/COLOR MODE..(TK-C625U)</b>	<p>For performing setting related to switching between the B&amp;W and Color modes.</p> <p><b>MEMO</b></p> <ul style="list-style-type: none"> <li>● When in the B&amp;W mode, this camera is sensitive to both visible and near-IR lights. As such, images may become out of focus upon switching from the Color to B&amp;W mode, depending on the type of light source used. In this case, re-adjust the focus in the B&amp;W mode. In addition, when the "AF FOR IR" (pg. 25) item is set to "ON", focus can be adjusted automatically during mode switching.</li> <li>● Make use of an IR light as and when necessary.</li> </ul>	—
<b>B&amp;W MODE</b>	<p>For setting the function on switching from Color to B&amp;W mode.</p> <p>COLOUR : Color mode at all times and will not switch to the B&amp;W mode. [For TK-C625U, this is displayed as "COLOR".] B&amp;W : B&amp;W mode at all times. AUTO : Switches automatically to the Color mode when brightness level of the object is high, and to the B&amp;W mode when brightness level of the object is low. ALARM IN : Switches to the B&amp;W mode when there is an alarm input. B&amp;W mode turns ON when input contact of the camera's input alarm is short (make), and B&amp;W mode turns OFF when the input contact is open (break).</p> <p><b>MEMO</b></p> <p><b>To ensure proper switching between B&amp;W/Color mode</b></p> <ul style="list-style-type: none"> <li>● Switching between the B&amp;W/Color mode can be performed automatically according to the brightness of the object by setting the "B&amp;W MODE" item to "AUTO". However, switching may fail depending on the lighting conditions and angle of view. In order to ensure proper switching, it is recommended that switching be performed by inputting signals from an external sensor (sold separately) to the alarm terminal of this camera.</li> </ul>	<p>TK-C625E: COLOUR</p> <p>TK-C625U: COLOR</p>
<b>LEVEL</b>	<p>For setting the signal level of the object at which switching to the B&amp;W mode is to be activated when the "B&amp;W MODE" (pg. 27) item is set to "AUTO".</p> <p>LOW : Switch to the B&amp;W mode when signal level of the object is low. NORMAL : Switch to the B&amp;W mode when signal level of the object is normal. HIGH : Switch to the B&amp;W mode when signal level of the object is high.</p> <p><b>MEMO</b></p> <ul style="list-style-type: none"> <li>● When the "B&amp;W MODE" item is set to a value other than "AUTO", "- -" will be displayed and setting of the LEVEL item will not be possible.</li> </ul>	NORMAL
<b>LIGHT TYPE</b>	<p>For setting the type of lighting used for the object when in the B&amp;W mode.</p> <p>NORMAL : Set to this when a normal light is used. IR : Set to this when using an infrared emission light.</p> <p><b>MEMO</b></p> <ul style="list-style-type: none"> <li>● Switching from the Color to B&amp;W mode may not function correctly if the "IR" setting is used under ordinary sunlight or fluorescent light.</li> </ul>	NORMAL

## CAMERA ALC/VIDEO Screen (continued)

Item	Function/Set Value	Initial Value
<b>COLOUR LEVEL (TK-C625E)</b> <b>COLOR LEVEL (TK-C625U)</b>	Adjusts the color level of video signals. To decrease..... Set a smaller value. To increase..... Set a larger value. [Set values: -5 to NORMAL to 5]	NORMAL
<b>ENHANCE LEVEL</b>	Sets the contour enhancement which controls the sharpness on the monitor screen. To soften the picture..... Set a smaller value. To sharpen the picture... Set a larger value. [Set values: -5 to NORMAL to 5]	NORMAL
<b>PEDESTAL LEVEL</b>	Sets the pedestal level (black level) of video signals. To darken the color..... Set a smaller value. To brighten the picture..... Set a larger value. [Set values: -5 to NORMAL to 5]	NORMAL

## AUTO PAN/PATROL/TRACE Screen

This screen enables setting of the Auto Pan function, which enables gradual horizontal rotation of the camera, the Auto Patrol function, which moves the camera to multiple positions in a predetermined sequence, as well as the Auto Trace function, which reproduces previous manual camera operations.

Item	Function/Set Value	Initial Value
<b>AUTO PAN SET..</b>	For setting Auto Pan movements. "AUTO PAN Setup" (pg. 38)	—
<b>AUTO PAN MODE</b>	For setting the rotating direction during Auto Pan. RETURN : Move between the start and end positions RIGHT : Rightward rotation LEFT : Leftward rotation	RETURN
<b>AUTO PAN SPEED</b>	For setting the rotating speed during Auto Pan. LOW : Rotation at low speed NORMAL : Rotation at normal speed HIGH : Rotation at high speed	NORMAL
<b>A. PAN POS. SET..</b>	For setting the start and end positions of Auto Pan when "RETURN" is selected.	—
<b>AUTO PATROL SET..</b>	For setting Auto Patrol movements. "AUTO PATROL Setup" (pg. 39)	—
<b>MODE</b>	For selecting a mode of Auto Patrol movement. [Set values: 1 to 3]	1
<b>POSITION</b>	For setting the sequence of patrol positions. The camera will perform Auto Patrol in this preset sequence of positions. [Set values: HOME, POSITION1 to 99]	—
<b>TIME</b>	For setting the duration of stop at each position. [Set values: SKIP, 10 s, 20 s, 30 s, 45 s, 1 min, 2 min]	10 s
<b>AUTO TRACE SET..</b>	For setting Auto Trace movements. "AUTO TRACE Setup" (pg. 40)	—

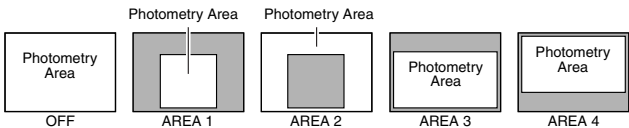
Item	Function/Set Value	Initial Value
<b>AUTO PAN TRACE/ VIDEO..</b>	For setting video images during Auto Pan and Auto Trace.	—
<b>IRIS MODE</b>	For setting the method of lens iris adjustment. AUTO : Adjusts iris automatically to the default state. AUTO+ : Adjusts iris automatically to a level brighter than the default state. AUTO- : Adjusts iris automatically to a level darker than the default state. MANUAL : Use this setting to adjust the iris manually.	AUTO
<b>AVERAGE : PEAK</b>	For setting the method of exposure detection according to the ratio between the average and peak values. ●Larger AVERAGE Value : Use this setting when areas other than those highlighted are dark and unclear. (Example: 10:0) ●Larger PEAK Value : Use this setting when halation is seen to occur at the highlighted areas on the screen. (Example: 5:5) [Set values: 10:0, 9:1, 8:2, 7:3, 6:4, 5:5]	8:2
<b>BLC MODE</b>	For setting the backlight compensation function. Use this setting when an object appears dark using the Auto Iris function due to the presence of a bright light source behind the object. Set in such a way that unnecessary light sources are placed outside the photometry area. OFF : Do not perform backlight compensation. AREA 1 to AREA 4 : Set according to the diagram below. 	OFF
<b>W. BALANCE</b>	For setting the white balance adjustment feature. White balance can be adjusted for lighting conditions within a color temperature range of 2,300 K to 10,000 K. ATW : Auto-Tracking White Balance mode. Adjusts the white balance automatically according to the color temperature of the lighting. During “ATW” setting, the “R GAIN” and “B GAIN” items are displayed as “- -” and hue adjustment is not possible. AWC : Switches to the Auto White Control mode and a message indicating “Set Start AWC” will be displayed. Press the SET button to enable the AWC function for white balance adjustment.	ATW
<b>R GAIN</b>	Adjusts the hue of R (red) when in the AWC mode. Increase value to enhance the red color. [Set values: 0 to 255]	—
<b>B GAIN</b>	Adjusts the hue of B (blue) when in the AWC mode. Increase value to enhance the blue color. [Set values: 0 to 255]	—
<b>RM. A. PAN KEY</b>	For setting the action upon pressing the AUTO PAN button on the remote control. A. PAN : Auto Pan function A. PATROL : Auto Patrol function A. TRACE : Auto Trace function	A. PAN
<b>RM. A. PATROL KEY</b>	For setting the action upon pressing the AUTO PATROL button on the remote control. A. PAN : Auto Pan function A. PATROL : Auto Patrol function A. TRACE : Auto Trace function	A. PATROL

## POS. FUNCTION SET Screen

Use this menu to perform setting related to positions.

Item	Function/Set Value	Initial Value
<b>POSITION TITLE..</b>	For setting a title (up to 16 characters) for the preset positions to be displayed on the screen. “POSITION TITLE Setup” (☞ pg. 41)	—
<b>IRIS MODE</b>	For setting the method of lens iris adjustment. AUTO : Adjusts iris automatically to the default state. AUTO + : Adjusts iris automatically to a level brighter than the default state. AUTO - : Adjusts iris automatically to a level darker than the default state. MANUAL : Use this setting to adjust the iris manually.	AUTO

## POS. FUNCTION SET Screen (continued)

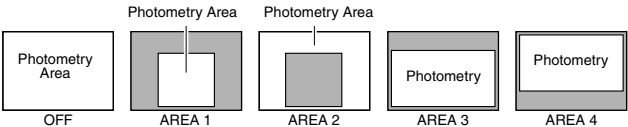
Item	Function/Set Value	Initial Value
<b>AVERAGE : PEAK</b>	<p>For setting the method of exposure detection according to the ratio between the average and peak values.</p> <ul style="list-style-type: none"> <li>•Larger AVERAGE Value : Use this setting when areas other than those highlighted are dark and unclear. (Example: 10:0)</li> <li>•Larger PEAK Value : Use this setting when halation is seen to occur at the highlighted areas on the screen. (Example: 5:5)</li> </ul> <p>[Set values: 10:0, 9:1, 8:2, 7:3, 6:4, 5:5]</p>	8:2
<b>BLC MODE</b>	<p>For setting the backlight compensation function. Use this setting when an object appears dark using the Auto Iris function due to the presence of a bright light source behind the object. Set in such a way that unnecessary light sources are placed outside the photometry area.</p> <p>OFF : Do not perform backlight compensation.            AREA 1 to AREA 4 : Set according to the diagram below.</p> 	OFF
<b>W. BALANCE</b>	<p>For setting the white balance adjustment feature. White balance can be adjusted for lighting conditions within a color temperature range of 2,300 K to 10,000 K.</p> <p>ATW : Auto-Tracking White Balance mode. Adjusts the white balance automatically according to the color temperature of the lighting. During "ATW" setting, the "R GAIN" and "B GAIN" items are displayed as "--" and hue adjustment is not possible.</p> <p>AWC : Switches to the Auto White Control mode and a message indicating "&lt;SET&gt; AWC EXEC" will be displayed. Press the SET button to enable the AWC function for white balance adjustment.</p>	ATW
<b>R GAIN</b>	<p>Adjusts the hue of R (red) when in the AWC mode.            Increase value to enhance the red color.            [Set values: 0 to 255]</p>	—
<b>B GAIN</b>	<p>Adjusts the hue of B (blue) when in the AWC mode.            Increase value to enhance the blue color.            [Set values: 0 to 255]</p>	—

## FACTORY SETTINGS Screen

Use this screen to restore the values set in the menu to their factory settings.

Item	Function/Set Value	Initial Value
<b>CANCEL</b>	Do not restore to factory settings. Press the MENU button or the SET button to return to the menu screen.	
<b>CLEAR (W/O POS. TITLE)</b>	<p>Restore factory settings. Upon pressing the SET button, a message indicating "FACTORY SETTINGS..." will be displayed for approximately 20 seconds, upon which the set values will be restored to their factory settings. Upon completion, a message indicating "DATA CLEARED" will appear.</p> <p>Preset positions as well as settings and titles for each position, however, will not be restored to their initial values. Returns to the menu screen upon completion.</p>	—
<b>CLEAR (ALL)</b>	<p>Upon pressing the SET button, a message indicating "FACTORY SETTINGS..." will be displayed for approximately 20 seconds, upon which the set values will be restored to their factory settings. Upon completion, a message indicating "DATA CLEARED" will appear.</p> <p>All settings including the titles and preset positions will be restored to their initial values. Returns to the menu screen upon completion.</p>	

## PRIVATE MASK Setup

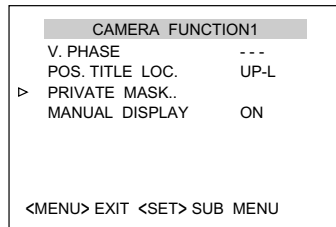
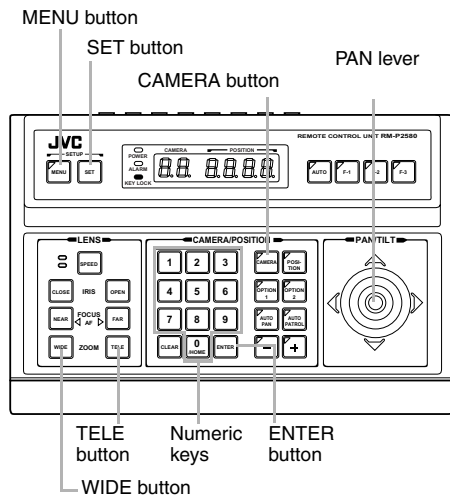

CAM. FUNCTION 1 screen

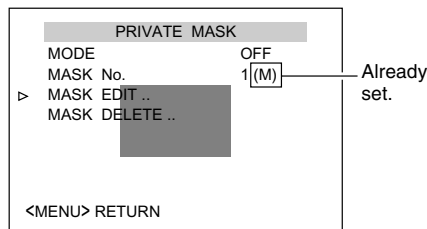

PRIVATE MASK screen

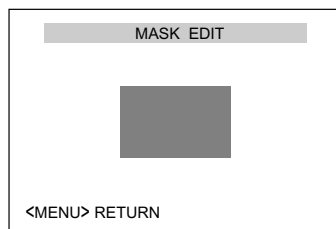

MASK EDIT screen

Use the PRIVATE MASK screen to set up the private mask function, which grays out areas that are not required to be included in the monitored picture. Up to four private masks can be set per screen, and up to eight private masks can be set in total.

### 1 Select the camera. (See RM-P2580 "INSTRUCTIONS")

**CAMERA button** → **Numeric key (Camera Number)** → **ENTER button**

- The picture of the selected camera is output.

### 2 Display the MENU screen. (See pg. 21, steps 2 to 4)

**MENU button** (3 sec.) → Select "CAMERA.." using the **PAN lever** → **SET button**.

- The "MENU" screen will be displayed.

### 3 Tilt the PAN lever up or down to move the cursor (▷) to "CAM. FUNCTION 1.." and press the SET button.

- The "CAMERA FUNCTION 1" screen is displayed.

### 4 Move the cursor (▷) to "PRIVATE MASK.." and press the SET button.

The "PRIVATE MASK" screen is displayed.

### 5 Select the private mask function ON or OFF.

Turn the private mask function on or off by setting the "MODE" item in the submenu to ON or OFF (Factory setting: OFF)

### 6 Select the mask number.

Select the private mask number from MASK No. 1 to No. 8 and move the cursor to the item "MASK EDIT..". A maximum of 4 can be set within one picture.

If an already set mask number is selected, the (M) mark will be displayed.

### 7 Edit the masking area.

- Move the cursor to "MASK EDIT.." and press the **SET button** to display the "MASK EDIT" screen. (The masked area will be displayed as a grayed-out area.)

- Tilt the **PAN lever** to move the grayed-out area to the center of the area to be masked.

- Press the **TELE button** and **WIDE button** to set the masked area size.

### ■ CAUTIONS

- It is not possible to set five or more masks in adjacent areas. (Even when this is attempted, the masked area that is required to be set will not be displayed.)
- MASK cannot be set at lower than approx. 40° in the horizontal direction. (The masks for new settings are not displayed.)

### 8 Press the MENU button.

- The screen returns to the "PRIVATE MASK" screen.

- To delete a private mask area, select "MASK DELETE..", move the cursor to "DELETE" and press the **SET button**. The PRIVATE MASK menu reappears after the data has been deleted.

- To cancel deletion, select "CANCEL" and press the **SET button**.

### 9 Repeat steps 6 to 8 for each additional mask area.

### 10 Press the MENU button.

The screen returns to the "CAMERA FUNCTION 1" menu.

### ■ CAUTIONS

- There may be cases, depending on the camera direction and zoom position, in which an object is captured from within the private mask area. After setting the private mask, be sure to vary the camera direction and zoom position in order to confirm that the camera does not capture objects from within this area.
- The Private Mask function cannot be carried out during the initializing process immediately after the power is turned on.
- When 4 masking areas are set within the same screen, setting of another mask in an adjacent area may fail. In this case, adjust the angle of view settings.
- When 4 marks are set on one same screen, the next mark might not be possible to set on the nearest area. In that case, set the angle of screen again.

# MANUAL PAN LIMIT Setup

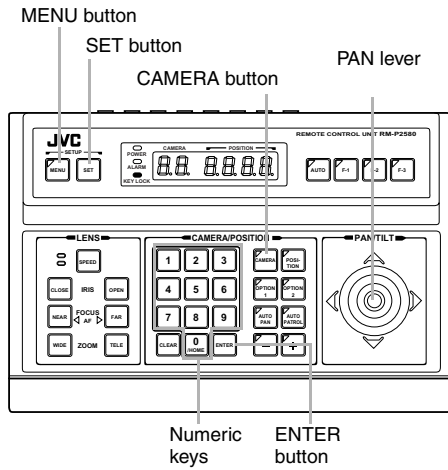

This section describes procedures for setting the Panning (horizontal) range during manual operation.

- 1 Select a camera.** (See RM-P2580 "INSTRUCTIONS")  
CAMERA button → Numeric key (Camera Number) → ENTER button
  - Video images of the selected camera will be output.
- 2 MENU screen display.** (See pg. 21, steps 2 to 4)  
MENU button (3 sec.) → Select "CAMERA.." using the PAN lever → SET button.
  - The "MENU" screen will be displayed.
- 3 Move the PAN lever upward/downward to shift the cursor (▷) to the "CAM. FUNCTION 2.." item, followed by pressing the SET button.**
  - The "CAMERA FUNCTION 2" screen will be displayed.
- 4 Shift the cursor (▷) to the "M. PAN LIMIT.." item, and move the PAN lever leftward/rightward to select "ON".**
  - The "CAMERA FUNCTION 2" screen will be displayed.
- 5 Press the SET button.**
  - The "M. PAN LIMIT POS.SET" screen (left limit) will be displayed.
- 6 Set the position for the left limit.**  
Use the PAN lever to determine the position for the left limit.
  - During setting, a message indicating "[L] POS. SETTING →" will be displayed at the bottom left of the screen.
- 7 Press the SET button.**
  - The screen will switch to the right limit setting screen.
- 8 Set the position for the right limit.**  
Use the PAN lever to determine the position for the right limit.
  - During setting, a message indicating "← [R] POS. SETTING" will be displayed at the bottom right of the screen.
- 9 Press the MENU button.**
  - This stores the limit positions that have been set and returns the screen to the "CAMERA FUNCTION 2" menu.

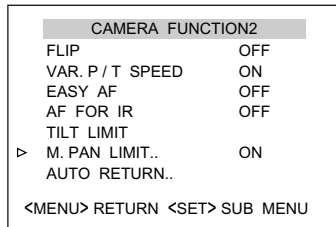

CAMERA FUNCTION 2 Screen

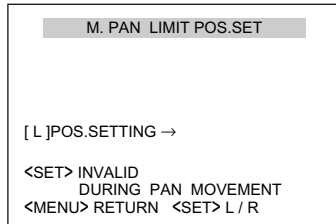

M. PAN LIMIT POS.SET Screen (Left Limit)

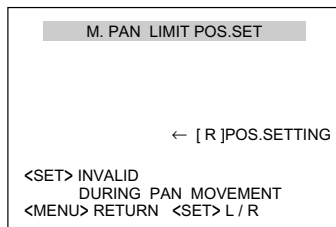

M. PAN LIMIT POS.SET Screen (Right Limit)

## MEMO

- Tilting, zooming and focusing operations are possible when this menu is displayed.
- If a pan limit has already been set, the camera will move to the left pan limit position when this menu is invoked.
- Setting cannot be performed when Panning is in progress. Press the SET button after Panning has come to a stop.
- Auto Flip operation will override this setting if the destination position of Auto Flip is outside the range as set in this item.
- Manual Pan Limit remains valid when setting preset positions.
- Movement to preset positions will be performed without regard to the Manual Pan Limit.
- The "M. PAN LIMIT.." item will not affect the following even when it is set to "ON".
  - PRIVATE MASK Settings
  - AUTO PAN POSITION Settings
  - AREA DISPLAY Settings



## MANUAL PAN LIMIT Setup (continued)

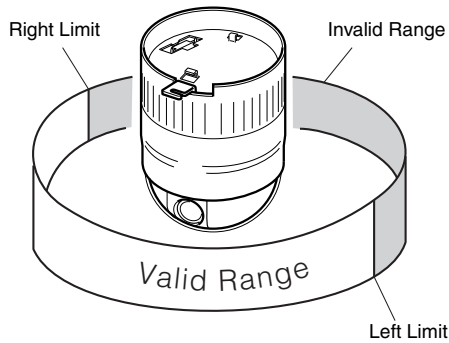

### ■ Basic operation of Manual Pan Limit

- Panning operation will only be allowed within the valid range upon setting the Manual Pan Limit.
- When the camera is moved by an operation that overrides the Manual Pan Limit into a region outside the valid panning range, the camera will function as follows when a manual Pan operation is performed.
- Pan operations can be freely performed outside the panning range until the camera enters the valid range again.
- Upon entering the valid range, Pan operation will only be possible within the Manual Pan Limit that has been set.

### ■ Operations that override the Manual Pan Limit

The following operations are performed without regard to the invalid range as set by the Manual Pan Limit.

- Auto Pan operation
- Auto Trace operation
- Movement to preset positions
- Auto Flip operation

### ■ Settings that override the Manual Pan Limit

The following settings involve Pan operations but setting can be performed without regard to the invalid range as set by the Manual Pan Limit.

- PRIVATE MASK Setup
- AUTO PAN Setup
- AREA DISPLAY Setup (TITLE)
- AREA DISPLAY Setup (DIRECTION)

### MEMO

- If the "M. PAN LIMIT." is "ON" during setting of Auto Trace and preset positions, Pan operation within the invalid range will not be possible. However, since Auto Trace and movement to preset positions are operations that override the Manual Pan Limit, panning within the invalid range of the Manual Pan Limit is possible if setting of Auto Trace and preset positions are performed prior to the MANUAL PAN LIMIT setup.

# CAMERA TITLE Setup

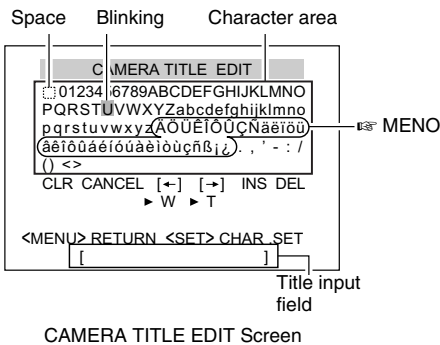
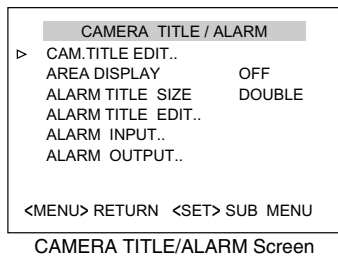
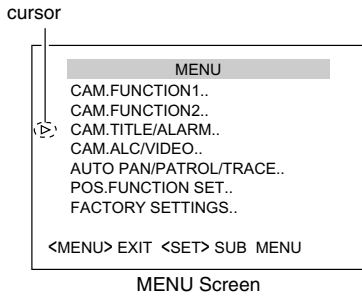
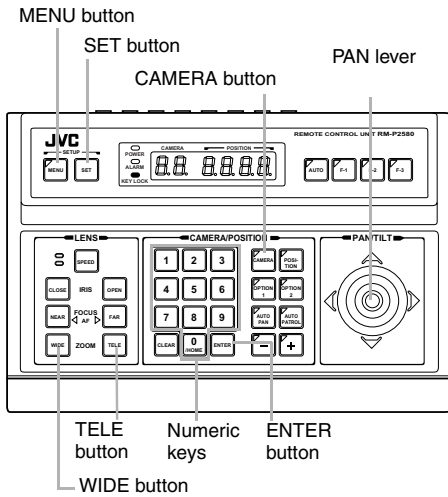

Use the CAMERA TITLE screen to set the title of each camera. Titles can be up to 16 characters in length and are displayed at the bottom left of the picture.

- 1 Select the camera.** (Refer to RM-P2580 "INSTRUCTIONS")  
CAMERA button → Numeric key (Camera Number) → ENTER button
  - The picture of the selected camera is output.
- 2 Display the MENU screen.** (Refer to pg. 21, steps 2 to 4)  
MENU button (3 sec.) → Select "CAMERA.." using the PAN lever → SET button.
  - The "MENU" screen will be displayed.
- 3 Tilt the PAN lever up or down to move the cursor (▷) to "CAMERA TITLE/ALARM.." and press the SET button.**
  - The "CAMERA TITLE/ALARM" menu is displayed.
- 4 Ensure that the cursor (▷) is located on "CAMERA TITLE EDIT.." and press the SET button.**
  - The "CAMERA TITLE EDIT" screen is displayed.
  - The first character appears blinking and input is enabled.
- 5 Use the PAN lever to select the first character of the title from the character area.**
  - The selected character will appear blinking.
- 6 Press the SET button.**
  - The first character of the title is now confirmed, and input of the second character is possible.
  - If the WIDE button is pressed, the title input field moves to the left. Use this to correct previously input characters.
- 7 Repeat steps 5 and 6 for each title character.**  
Complete the input of the title for the selected camera in the same way.
- 8 Press the MENU button.**
  - This stores the camera title that has been set and returns the screen to the previous menu.
  - To set the titles for multiple cameras, repeat steps 1 to 7 for each camera.

## MEMO

- Only displayed for the TK-C625E model.

# AREA DISPLAY Setup (TITLE)

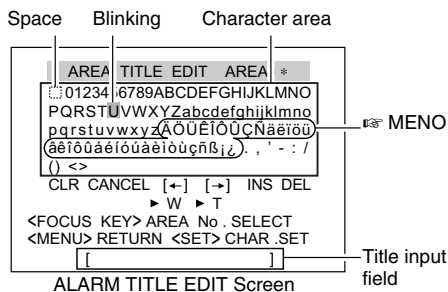
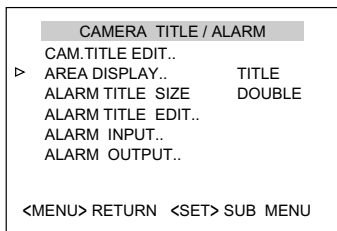
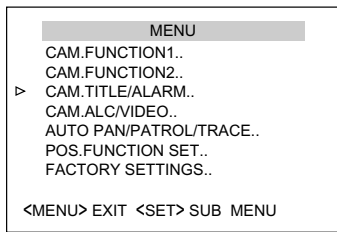
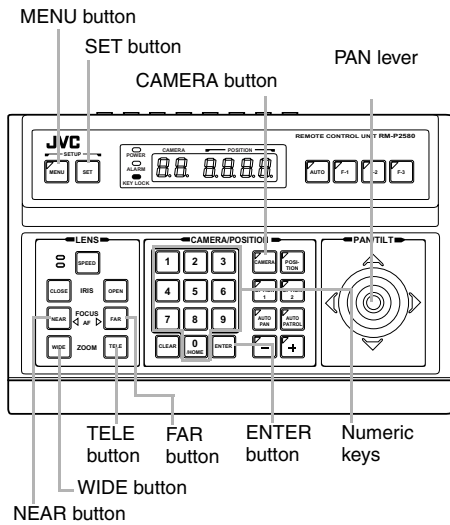
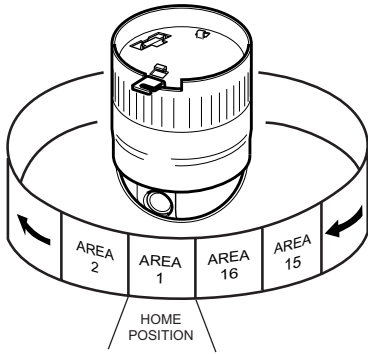

This section describes procedures to display area titles on the screen, when the 360° panning (horizontal) range is divided into 16 areas and when the camera is manually rotated. Title for each area can be specified up to 16 characters. (Turning ON/OFF Area Title display “AREA DISPLAY” (pg. 26))

- 1 Select a camera.** (RM-P2580 “INSTRUCTIONS”)
  - CAMERA button—Numeric key (Camera Number)—ENTER button
    - Video images of the selected camera will be output.
- 2 Display the MENU screen.** (pg. 21, steps 2 to 4)
  - MENU button (3 sec.) → Select “CAMERA..” using the PAN lever → SET button.
    - The “MENU” screen will be displayed.
- 3 Move the PAN lever upward/downward to shift the cursor (▷) to the “CAM. TITLE/ALARM..” item, followed by pressing the SET button.**
  - The “CAMERA TITLE/ALARM” screen will be displayed.
- 4 Shift the cursor (▷) to the “AREA DISPLAY” item, move the PAN lever leftward/rightward to select the “TITLE”, followed by pressing the SET button.**
  - The “AREA TITLE EDIT AREA 1” screen will be displayed. (Home position corresponds to AREA 1)
  - The first character appears blinking and input is enabled.
- 5 Move the PAN lever upward/downward or leftward/rightward to select the first character to input.**
  - The selected character will appear blinking.
- 6 Press the SET button.**
  - The first character of the title is now confirmed and input of the second character is possible.
  - Press the WIDE button to move the blinking cursor in the Title Input Field leftward. Use this when amending the set title.
- 7 Press the FAR button.**
  - The camera moves to the next area and the “AREA TITLE EDIT AREA 2” screen will be displayed.
  - Press the NEAR button to return to the previous area . The previous “AREA TITLE EDIT AREA 1” screen will be displayed.
- 8 Repeat Steps 5 to 7.**
  - Repeat procedure to enter a title for each area. (AREA 1 to AREA 16)
- 9 Press the MENU button.**
  - The set area title will be stored and the screen will return to the previous menu.

**MEMO**

- Only displayed for the TK-C625E model.

## AREA DISPLAY Setup (DIRECTION)

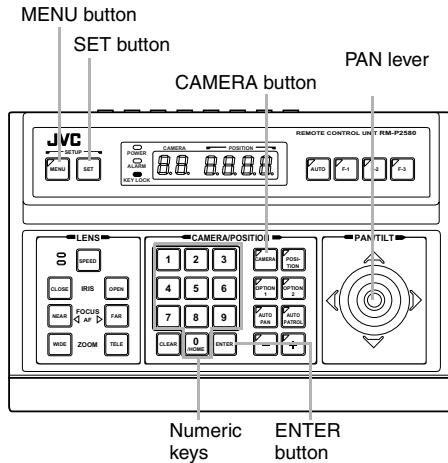
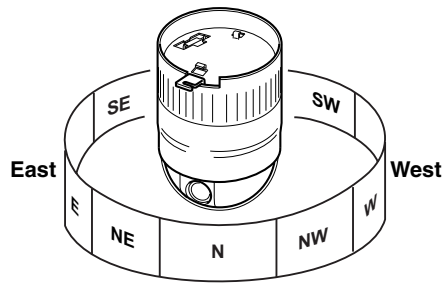

Upon setting N (North), which is the standard axis, the 360° panning range will be equally divided into 8 areas. Perform manual panning of the camera and each area will be displayed as N, NE, E, SE, S, SW, W, NW.

- 1 Select a camera.** (☞ RM-P2580 “INSTRUCTIONS”)
  - CAMERA button → Numeric key (Camera Number) → ENTER button
  - Video images of the selected camera will be output.
- 2 Display the MENU screen.** (☞ pg. 21, steps 2 to 4)
  - MENU button (3 sec.) → Select “CAMERA..” using the PAN lever → SET button.
  - The “MENU” screen will be displayed.
- 3 Move the PAN lever upward/downward to shift the cursor (▷) to the “CAM. TITLE/ALARM..” item, followed by pressing the SET button.**
  - The “CAMERA TITLE/ALARM” screen will be displayed.
- 4 Shift the cursor (▷) to the AREA DISPLAY item, and move the PAN lever leftward/rightward to select “DIR”.**
- 5 Press the SET button.**
  - The “DIRECTION STANDARD AXIS” screen will be displayed.
- 6 Move the PAN lever leftward/rightward to set the direction (N) of the standard axis.**
- 7 Press the MENU button.**
  - This sets the start position of the direction axis, which will be displayed on the top left of the screen.
  - Directions are displayed as N (north), NE (north-east), E (east), SE (south-east), S (south), SW (south-west), W (west) and NW (north-west) respectively.

### MEMO

- Tilting, zooming and focusing operations are possible when this menu is displayed.
- If a start position for the direction axis has already been set, the camera will move to this start position when this menu is invoked.

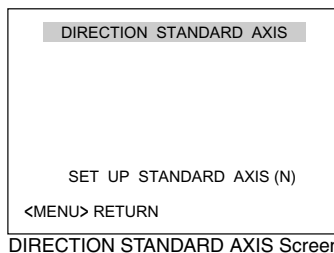
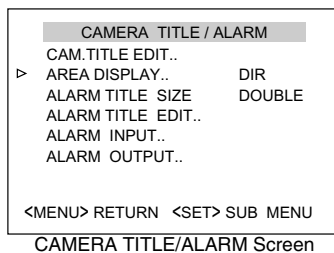
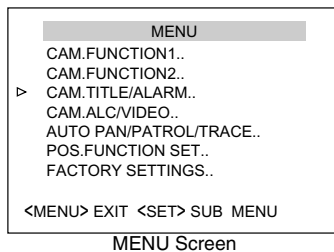

# ALARM TITLE Setup

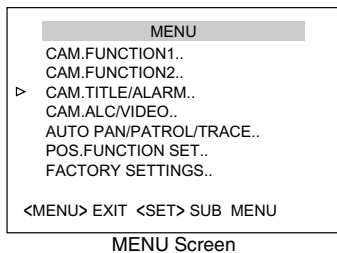
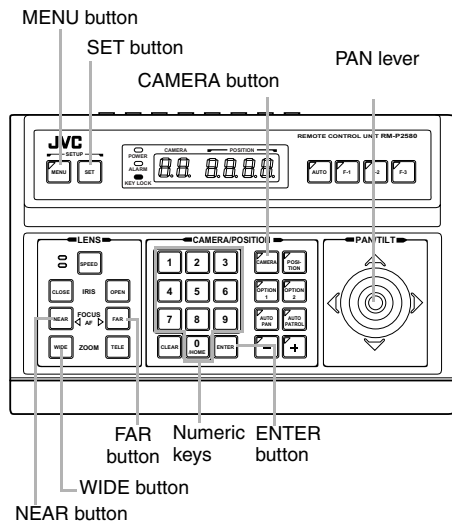

MENU Screen

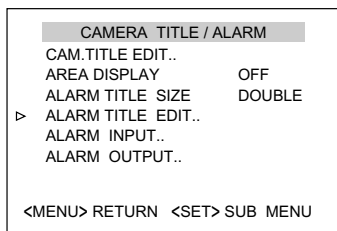

CAMERA TITLE/ALARM Screen

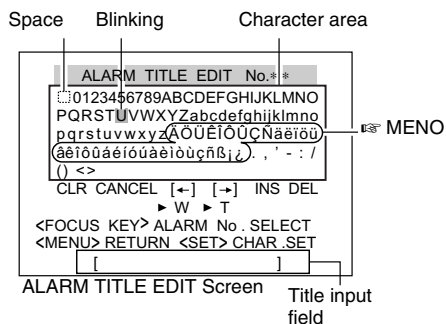

ALARM TITLE EDIT Screen

Use the ALARM TITLE screen to set the alarm titles to be displayed when an alarm signal is transmitted. Up to 10 alarm titles (ALARM TITLE 1 to 10) can be set and each title can be up to 12 characters in length.

- 1 Select the camera.** (Refer to RM-P2580 "INSTRUCTIONS")  
CAMERA button → Numeric key (Camera Number) → ENTER button
  - The picture of the selected camera is output.
- 2 Display the MENU screen.** (Refer to pg. 21, steps 2 to 4)  
MENU button (3 sec.) → Select "CAMERA.." using the PAN lever → SET button.
  - The "MENU" screen will be displayed.
- 3 Tilt the PAN lever up or down to move the cursor (▷) to "CAM. TITLE/ALARM.." and press the SET button.**
  - The "CAMERA TITLE/ALARM" screen is displayed.
- 4 Move the cursor (▷) to the "ALARM TITLE EDIT.." item and press the SET button.**
  - The "ALARM TITLE EDIT No.1" screen will be displayed.
  - The first character appears blinking and input is enabled.
- 5 Use the PAN lever to select the first character of the title from the character area.**
  - The selected character will appear blinking.
  - The selected character is displayed in the title input field.
- 6 Press the SET button.**
  - The first character of the title is now confirmed, and input of the second character is possible.
  - If the WIDE button is pressed, the title input field moves to the left. Use this to correct previously input characters.
- 7 Press the FAR button.**
  - The next "ALARM TITLE EDIT No.2" screen is displayed.
  - If the NEAR button is pressed, the previous "ALARM TITLE EDIT No.1" screen is displayed.
- 8 Repeat steps 5 to 7 for each alarm title.**  
Complete the input of all the alarm titles ("ALARM TITLE EDIT" 1 to 10) in the same way.
- 9 Press the MENU button.**
  - The screen returns to the previous menu.

## MEMO

- Only displayed for the TK-C625E model.

**RM-P2580 units need to be configured to display alarm titles. Use the RM-P2580 menu settings to do this:**

- 1** Press and hold the **MENU** button for 3 seconds to display the SETUP screen on the remote control unit.
- 2** First select the "CONTROL UNIT.." screen, then the "DATA I/O" screen and finally the "INPUT ASSIGNMENT" screen.
- 3** Select "ALARM TEXT" then "EDIT 1", the alarm title set as "ALARM TITLE EDIT 1" is displayed on the monitor.

\* The alarm signals are input into the DATA I/O terminals on the rear panel of the RM-P2580.

## AUTO PAN Setup

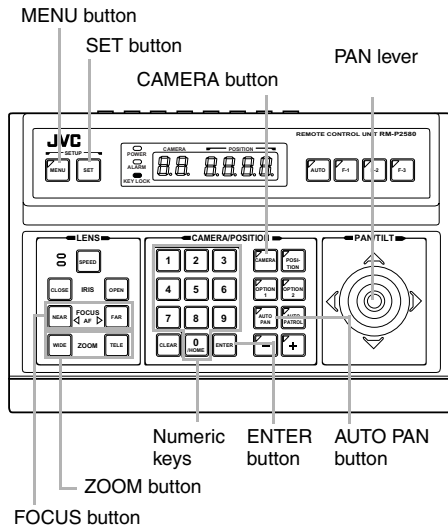
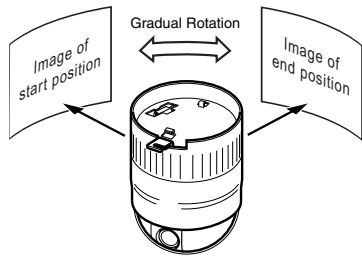

This section describes procedures for setting the Auto Pan function, which enables gradual horizontal rotation of the camera. There are 3 Auto Pan modes, namely movement between 2 points, rightward rotation and leftward rotation.

- 1 Select camera.** (☞ RM-P2580 "INSTRUCTIONS")  
CAMERA button → Numeric key (Camera Number) → ENTER button
  - Video images of the selected camera will be output.
- 2 Display the MENU screen.** (☞ pg. 21, steps 2 to 4)  
MENU button (3 sec.) → Select "CAMERA.." using the PAN lever → SET button.
  - The "MENU" screen will be displayed.
- 3 Move the PAN lever upward/downward to shift the cursor (▷) to the "AUTO PAN/PATROL/TRACE.." item, followed by pressing the SET button.**
  - The "AUTO PAN/PATROL/TRACE" screen will be displayed.
- 4 Press the SET button.**
  - Check that the cursor is at the "AUTO PAN SET.." item and press SET button.
- 5 Set the AUTO PAN MODE and AUTO PAN SPEED.**
  - Set the type of Auto Pan movement using the AUTO PAN MODE item. RETURN (Movement between 2 points), RIGHT and LEFT
  - Set the rotating speed of Auto Pan using the AUTO PAN SPEED item. LOW, NORMAL, HIGH
- 6 Shift the cursor (▷) to the "A. PAN POS. SET.." item, and press the SET button (only when in the RETURN mode).**
  - The "AUTO PAN POSITION SET" screen will be displayed.
- 7 Adjust the angle of view at the start position (only when in the RETURN mode).**
  - Use the PAN lever, FOCUS button and ZOOM button for adjustment.
  - Tilting operations or lens operations such as focusing and zooming are not possible at the return position.
  - During setting, a message indicating "[START] POS.SET →" will be displayed at the bottom left of the screen.
- 8 Press the SET button (only when in the RETURN mode).**  
This switches the start position to the end position.
- 9 Set the end position (only when in the RETURN mode).**
  - Set the return position using the PAN lever.
  - During setting, a message indicating "← [END] POS.SET" will be displayed at the bottom right of the screen.
- 10 Press the MENU button.**  
The Auto Pan position that has been set will be stored and the screen will return to the previous menu ("AUTO PAN SET" screen).

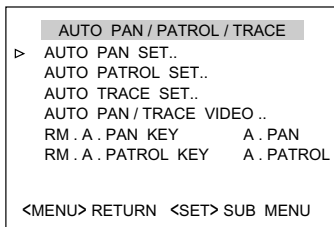

AUTO PAN/PATROL/TRACE screen

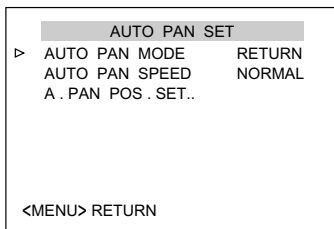

AUTO PAN SET screen

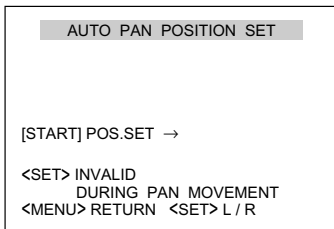

AUTO PAN POSITION SET screen

### MEMO

- Vertical movement (tilting) and lens operations are not possible at the return position.
- Writing of preset data may fail if the SET button or MENU button is pressed when the camera is moving. Ensure that the camera has come to a stop before pressing the SET button and MENU button.
- The Manual Pan Limit mode will be temporarily turned OFF when this menu is displayed. Manual Pan Limit can be set upon exiting this menu without affecting the Auto Pan operation.

To enable Auto Pan operation upon setting, press the **AUTO PAN** button on RM-P2580.

☞ RM-P2580 "Auto Pan operation", INSTRUCTIONS

# AUTO PATROL Setup

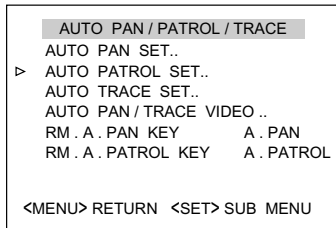
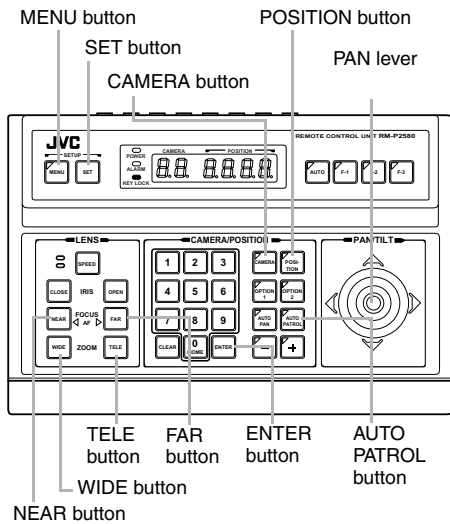
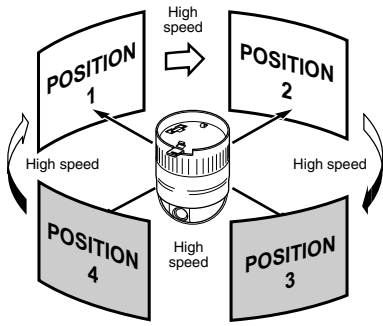

AUTO PAN/PATROL/TRACE Screen

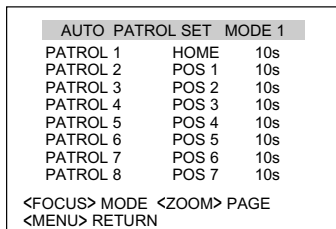

AUTO PATROL SET MODE 1 Screen (Example showing PATROL Nos.1 to 8)

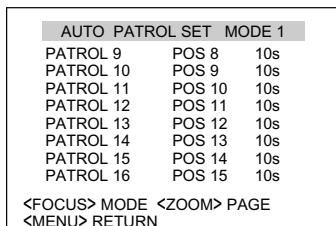

AUTO PATROL SET MODE 1 Screen (Example showing PATROL Nos. 9 to 16)

Use the AUTO PATROL screen to set the configuration of the Auto Patrol function, which moves the camera between several positions at a high speed. Patrol positions 1-100 can be set in each of three modes (MODES 1 to 3). It is recommended that these three modes be set according to the day of the week or the time of day. For example: MODE 1 for nighttime and MODE 2 for daytime.

- 1 Select the camera.** (See RM-P2580 "INSTRUCTIONS")  
CAMERA button—Numeric key (Camera Number)—ENTER button
  - The picture of the selected camera is output.
- 2 Display the MENU screen.** (See pg. 21, steps 2 to 4)  
MENU button (3 sec.) → Select "CAMERA.." using the PAN lever → SET button.
  - The "MENU" screen will be displayed.
- 3 Tilt the PAN lever up or down to move the cursor (▷) to "AUTO PAN/PATROL/TRACE.." and press the SET button.**
  - The "AUTO PAN/PATROL/TRACE.." screen is displayed.
- 4 Move the cursor (▷) to "AUTO PATROL SET.." and press the SET button.**
  - The "AUTO PATROL SET MODE 1" screen is displayed.
- 5 Tilt the PAN lever to move the cursor (▷) to the PATROL position to be set.**
  - To display the next page (PATROL positions 9 to 19), press the TELE button.
  - To display the previous page, press the WIDE button.
- 6 Set a patrol position.**  
POSITION button→Numeric key (position number) → ENTER button
  - Positions from PATROL 1 to 100 are set in the order of HOME, followed by POS 1 to POS 99.
- 7 Set the length of time a camera will stay in each position.**
  - Use the PAN lever to the left or right to set the time period.
  - Available set values: SKIP, 10s, 20s, 30s, 45s, 1min, 2min. (Selecting "SKIP" skips that position and moves to the next position.)
  - The factory setting is 10s for all positions.
- 8 Repeat steps 5 to 7 for each patrol position.**
  - Set the patrol positions and time periods of all patrol numbers in the same way.
- 9 Change the Auto Patrol mode.**
  - Press the FAR button or NEAR button to change the mode.
  - After changing to a new mode, repeat steps 5 to 8.
- 10 Press the MENU button.**
  - The screen returns to the previous menu.

- After the above setup, Auto Patrol of the camera can be started by pressing the AUTO PATROL button on the RM-P2580.
- To change the Auto Patrol mode after the above setup, display the AUTO PATROL SET MODE screen and press the FAR button or NEAR button.
- The Auto Patrol function can only be set from an RM-P2580. Note that it differs to auto sequence operations available with other remote control units.



## AUTO TRACE Setup

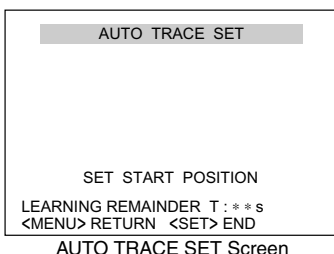
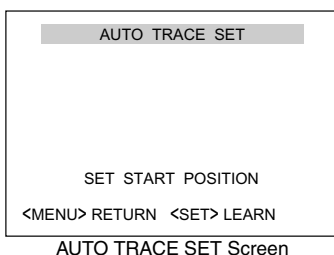
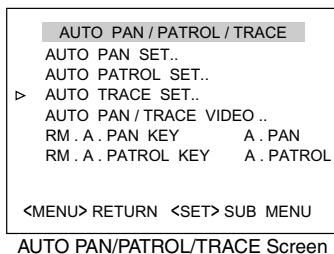
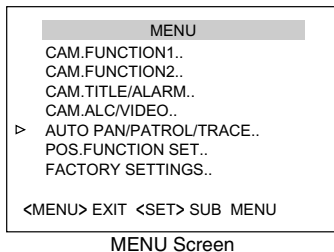
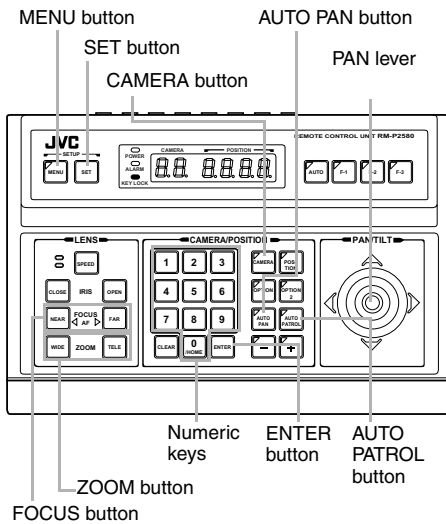

Use the AUTO TRACE screen to set the Auto Trace function, which stores and reproduces the actions of a manual camera operation (up to 30 seconds).

- 1 Select the camera.** (☞ RM-P2580 "INSTRUCTIONS")  
CAMERA button → Numeric key (Camera Number) → ENTER button
  - The picture of the selected camera is output.
- 2 Display the MENU screen.** (☞ pg. 21, steps 2 to 4)  
MENU button (3 sec.) → Select "CAMERA.." using the PAN lever → SET button.
  - The "MENU" screen will be displayed.
- 3 Tilt the PAN lever up or down to move the cursor (▷) to "AUTO PAN/PATROL/TRACE.." and press the SET button.**
  - The "AUTO PAN/PATROL/TRACE" screen is displayed.
- 4 Move the cursor (▷) to "AUTO TRACE SET.." and press the SET button.**
  - The "AUTO TRACE SET" screen is displayed.
- 5 Set the patrol start position.**  
Using the PAN lever and the ZOOM button and FOCUS button, set the camera position at which the Auto Trace function is to be started.
- 6 Press the SET button (to start memorization of manual camera operations).**
  - Auto Trace starts. Operate the camera using the PAN lever, and the ZOOM button and FOCUS button.
  - The Auto Trace function can memorize camera operations for up to 30 seconds, during this period "LEARNING REMAINDER T: \*\*s" is displayed in the screen.
  - Storage finishes automatically after 30 seconds.
  - Perform step 7 only when finishing the storage but before 30 seconds elapses.
  - Recording time may shorten depending on details of the operation. (Shortest recording duration is approximately 10 seconds)
- 7 Press the SET button to end the memorization of manual camera operations.**
  - This ends recording of Auto Trace and a message indicating "DATA SAVED" will be displayed.
- 8 Press the MENU button.**
  - The screen returns to the "AUTO PAN/PATROL/TRACE" menu.

### MEMO

- Saving of auto operations will not be possible when this menu is displayed.
- Manual Pan Limit remains valid when this menu is displayed.
- Manual Pan Limit can be set upon exiting this menu without affecting the Auto Trace operation.
- Auto Trace allows easy recording of manual operations, but positions may not be accurately reproduced during playback.

### To Start Auto Trace Function

To let the camera execute reproduction of the Auto Trace operation, it is required to set the Auto Trace function in the **AUTO PAN** button or **AUTO PATROL** button of the RM-P2580.

☞ "RM. A. PAN KEY" (☞ pg. 29) and "RM. A. PATROL KEY" (☞ pg. 29). When the button to which the Auto Trace function is set is pressed, the lamp in the button lights up and Auto Trace reproduction starts.

The Auto Trace reproduction will repeat continually with a pause of 30 seconds between each operation.

To end the Auto Trace reproduction, press the button to which the Auto Trace function is set again so that the lamp in the button turns off.



# POSITION TITLE Setup

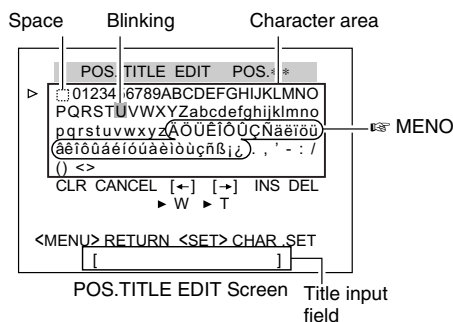
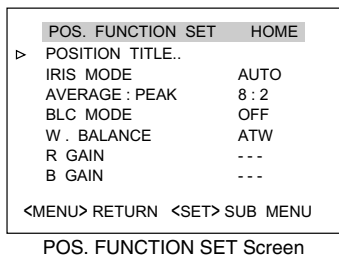
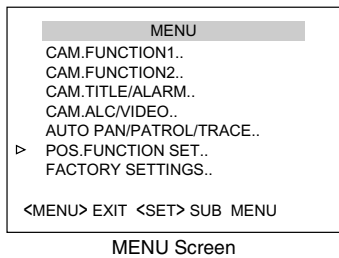
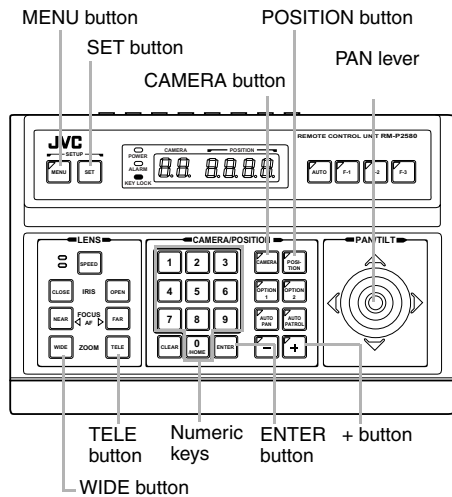

Use the POSITION TITLE screen to set the title of each camera position. Each camera position can be given a title of up to 16 characters.

- 1 Select the camera.** (See RM-P2580 "INSTRUCTIONS")  
CAMERA button → Numeric key (Camera Number) → ENTER button
  - The picture of the selected camera is output.
- 2 Display the MENU screen.** (See pg. 21, steps 2 to 4)  
MENU button (3 sec.) → Select "CAMERA.." using the PAN lever → SET button.
  - The "MENU" screen will be displayed.
- 3 Tilt the PAN lever up or down to move the cursor (▷) to "POS. FUNCTION SET.." and press the SET button.**
  - The "POS. FUNCTION SET" screen is displayed.
- 4 Ensure that the cursor (▷) is moved onto the item "POSITION TITLE.." item and press the SET button.**
  - The "POS.TITLE EDIT" screen is displayed.
  - The first character appears blinking and input is enabled.
- 5 Select a preset position.** (See RM-P2580 "INSTRUCTIONS")  
POSITION button → Numeric key (position number) → ENTER button
  - The picture of the selected camera position is output.
  - The next position can be selected simply by pressing the + button.
- 6 Use the PAN lever to select the first character of the title from the character area.**
  - The selected character will appear blinking.
- 7 Press the SET button.**
  - The first character of the title is now confirmed, and the system gets ready for the input of the second character is possible.
  - If the WIDE button is pressed, the title input field moves to the left. Use this to correct previously input characters.
- 8 Repeat steps 5 to 7 for each title character.**
  - When the next position is selected, the previous position title is stored in the memory.
  - Complete the input of all position titles in the same way.
- 9 Press the MENU button.**
  - The screen returns to the previous menu.

## MEMO

- Only displayed for the TK-C625E model.

## Troubleshooting

Symptom	Cause (Information)	Remedy
<b>Picture is not displayed.</b>	Is there a problem in the power cable(s) connecting the camera to the power supply unit? (If the power cable(s) are too long or of an inadequate size, the correct voltage may not be supplied due to an increase in cable resistance.)	Use cable(s) with low cable resistance and of the correct cable length. (Ensure that the voltage supplied to the terminal board is correct during camera operation, i.e. when the rated current is flowing through the camera.)
<b>Power cannot be turned on.</b>	Are cables connected properly to the terminal board on the Ceiling Mount ?	Connect the cables properly.
<b>Power can be turned on but it later turns off when the pan/tilt mechanism starts operation.</b>	Is there a problem with the power cable(s) connecting the camera to the power supply unit? (If the power cable(s) are too long or of an inadequate size, the correct voltage may not be supplied due to an increase in cable resistance during the pan/tilt operation.)	Change power cable(s) to one with of lower resistance (i.e. thicker or shorter cable(s)). (  pg. 13, "Switch Settings")
<b>Video sync error occurs.</b>	<ul style="list-style-type: none"> <li>●When LL is set, does the power supply frequency match the video frequency (PAL: 50 Hz, NTSC: 60 Hz)?</li> <li>●Is there any serious noise interference in the power supply?</li> </ul>	<ul style="list-style-type: none"> <li>●Use a stable power supply with a matching frequency.</li> <li>●Prevent noise interference from occurring in the power supply.</li> </ul>

# Specifications

## ■ Camera

Image pickup device: 1/4 type, interline transfer CCD  
 TK-C625E: 752 (H) x 582 (V) pixels  
 TK-C625U: 768 (H) x 494 (V) pixels

Sync system : Internal, Line Lock  
 Video output : VBS 1V (p-p) 75 Ω  
 Scanning frequencies : TK-C625E: 15.625 (H), 50 Hz (V)  
 TK-C625U: 15.734 (H), 59.94 Hz (V)  
 S/N : 50 dB (typical) (AGC mode: OFF, Enhance level: -5)  
 Horizontal resolution : 540 lines and above (typical) (WIDE end, Centre)  
 Minimum object illumination :  
 Color mode : 3.6 lx (50 % output, AGC 20 dB, WIDE end)  
 1.8 lx (25 % output, AGC 20 dB, WIDE end)  
 B&W mode : 0.15 lx (50 % output, AGC 20 dB, WIDE end)  
 White balance : TTL auto tracking/Manual  
 Electronic shutter :  
 TK-C625E : 1/50 (standard), 1/120 (60 Hz flickerless),  
 1/250, 1/500, 1/1000, 1/2000, 1/4000,  
 1/10000  
 TK-C625U : 1/60 (standard), 1/100 (50 Hz flickerless),  
 1/250, 1/500, 1/1000, 1/2000, 1/4000,  
 1/10000

Backlight compensation: Possible, 4 photometry areas selectable  
 Color level adjustment: Possible  
 Contour correction: Both horizontal and vertical (level adjustable)

## ■ Lens

Zoom ratio : Approx. x12  
 Focal distance : 3.8 mm to 45.6 mm  
 Maximum aperture : F1.6 (WIDE) to F2.7 (TELE)

## ■ Pan/Tilt Mechanism

Panning range : 360° endless revolution  
 Panning speed : 1.5°/s to 180°/s  
 Tilting range : 0° to 90° (Horizontal – Straight downwards – Horizontal)  
 Tilting speed : 1°/s to 120°/s

## ■ General

Power supply : TK-C625E: AC 24 V, 50 Hz, 1.5 A  
 TK-C625U: AC 24 V, 60 Hz, 20 W  
 No. of preset positions : 100  
 Applicable control unit : RM-P2580  
 Ambient temperature : -10°C to 50°C (operating),  
 0°C to 40°C (recommended)  
 Ambient humidity : 35 % to 90 % RH  
 (without condensation)  
 Mass : 1.3 kg

### Accessories:

TK-C625E	:	Instructions .....	2
	:	Ceiling Mount .....	1
	:	Template .....	1
	:	Wire Clamp .....	1
TK-C625U	:	Instructions .....	1
	:	Warranty Card .....	1
	:	Service Information Card .....	1
	:	Ceiling Mount .....	1
	:	Template .....	1
	:	Ferrite Core .....	1
	:	Wire Clamp .....	1

## ■ External Dimensions [Unit: mm]

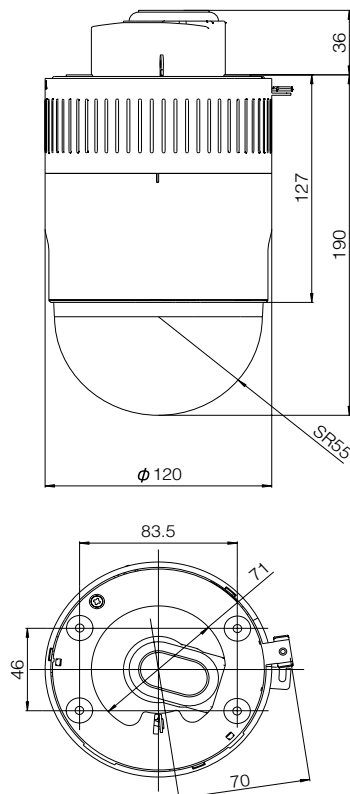

## ■ Ceiling Mount Hole [Unit: mm]

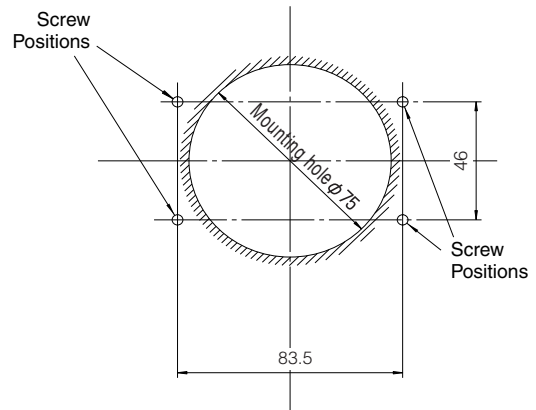

● Specifications and appearance of this unit and related products are subject to change for product improvement without prior notice.

TK-C625 DOME TYPE CAMERA

---

**JVC**